



SINCE 2012

PRODUCTS

**BUILDING
QUALITY**



JERIEL PRODUCTS



**JERIEL PRODUCTS PROVIDES HIGH
QUALITY BUILDING ACCENTS AND
FINISHES. WHETHER IT'S QUALITY
CRAFTED COLUMNS OR TRADITIONAL
BOARD AND BATTEN SHUTTERS,
WE CAN MEET YOUR NEEDS.**



JERIEL PRODUCTS

Jeriel Products, LLC, is a family owned and operated company proudly serving the Southeast since 2012. Specializing in architectural accents, we provide quality products including columns, shutters, vents, brackets and corbels. Our number one goal is not just to build and sell quality products to our customers but to become a vital part of their project team. The managing partners have a combined 70 years of experience in the construction industry. This experience allows Jeriel Products to manufacture quality products that add curb appeal to your project. Whether it is one of our standard products or one manufactured per your specifications, we will strive to meet your individual needs. You may purchase our products as a wholesale vendor or through a retailer in the Southeast.

ABOUT JERIEL



BRACKETS, CORBELS & BRACES

Gable brackets, corbels and braces are an excellent addition to the exterior of the home. They can also be used on commercial projects to add architectural interest and details.

These handcrafted pieces look great in free standing structures such as gazebos and pergolas and are a perfect way to dress up porches and entrances. These architectural elements will add dramatic character to your building project.



AVAILABLE IN:
WESTERN RED CEDAR,
PRESSURE TREATED
AND PVC

OTHER MATERIALS ARE
AVAILABLE UPON REQUEST



20-3/4"
20-3/4"
26"



SUPPORT MANY ARCHITECTURAL ITEMS, INCLUDING A WALL, BALCONY, PARAPETS, EAVES, THE SPRING OF AN ARCH, BEAMS, PERGOLA ROOF, WINDOW BOX OR A SHELF

BRACKETS

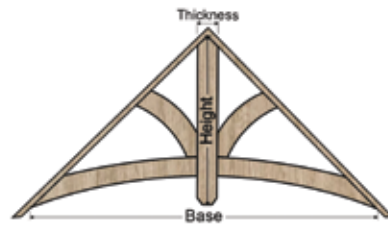

Arched Gable Bracket

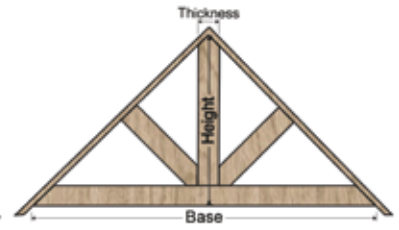

Straight Gable Bracket

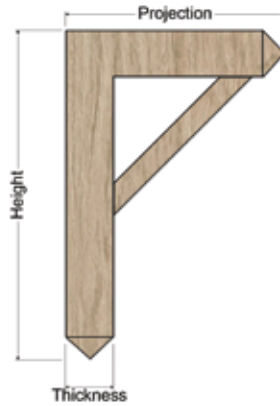

Corner Bracket

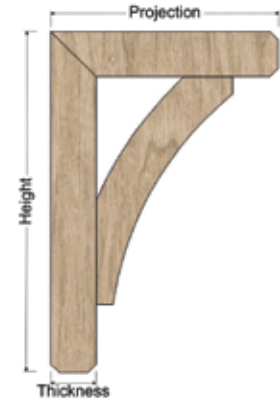

Arched Corner Bracket



THE VERTICAL AND HORIZONTAL PARTS OF THE CORBEL CREATE A VISUAL DECORATIVE ELEMENT TO THE PROJECT.

CORBELS

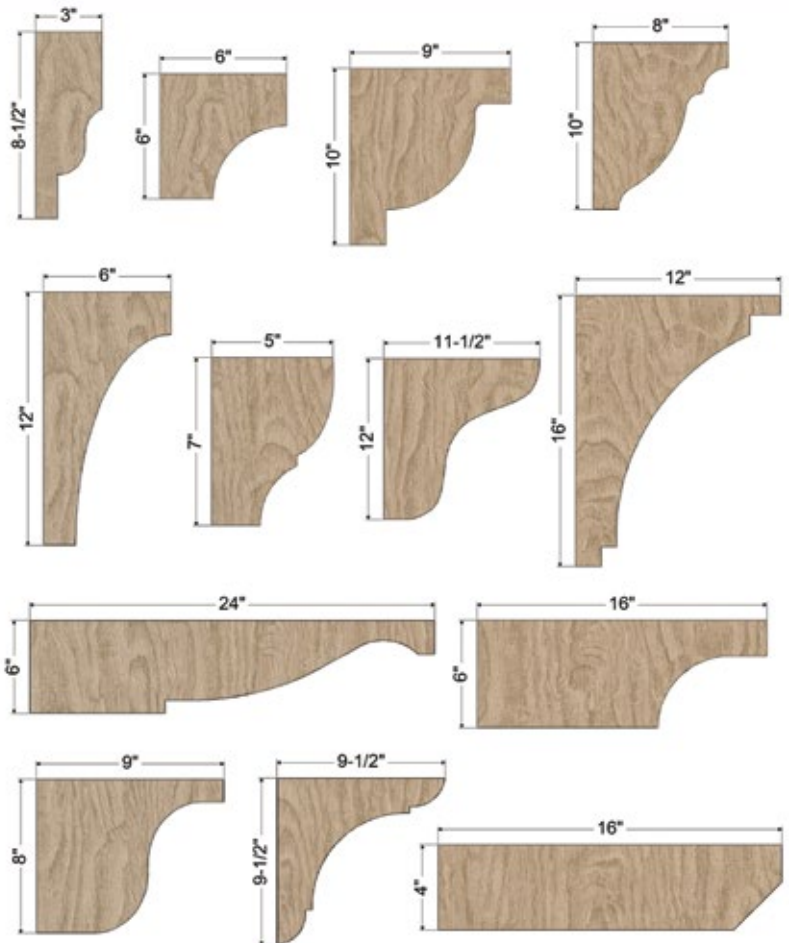

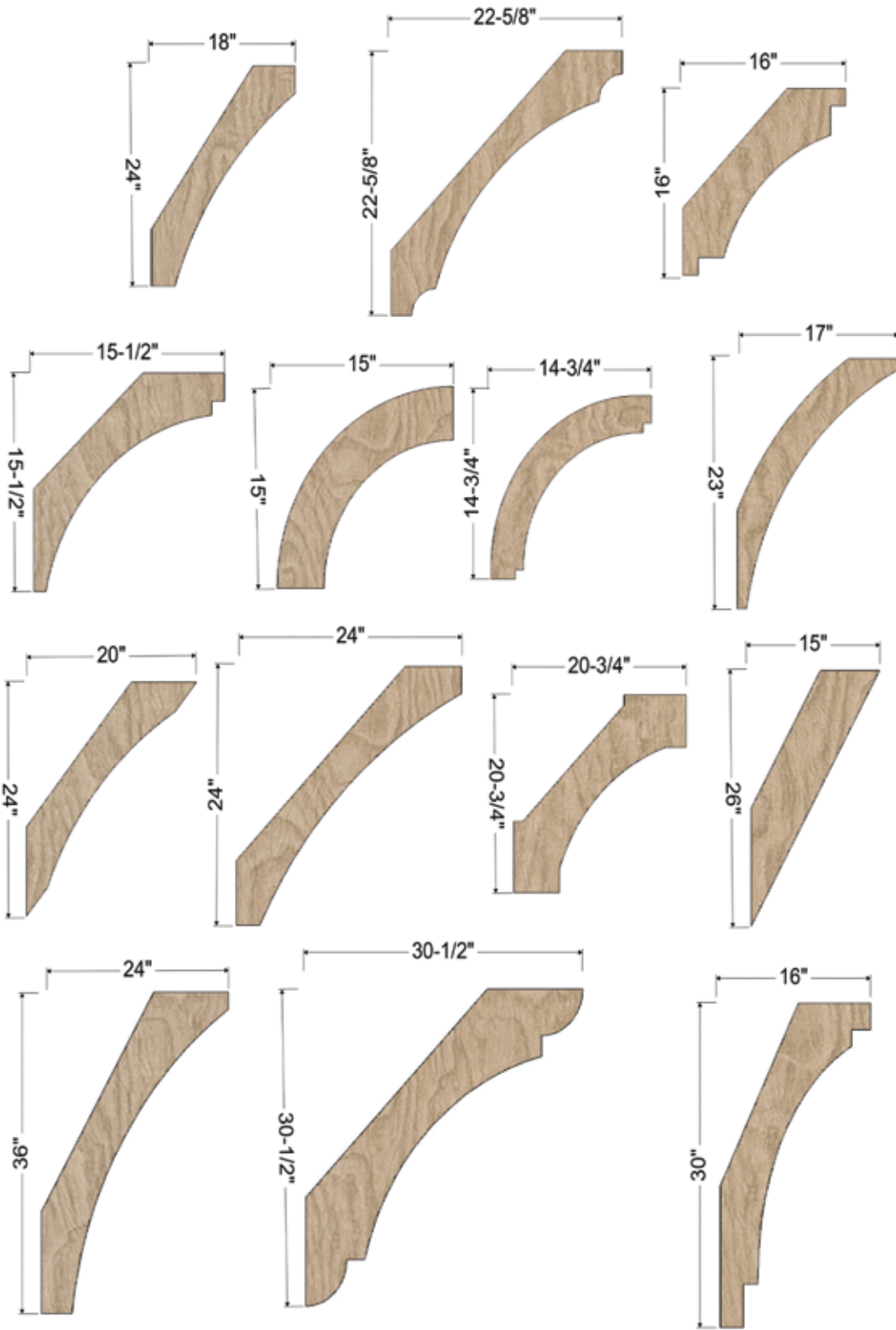

COME IN A VARIETY OF STYLES TO BRING STYLE TO SUPPORTIVE ELEMENTS ON THE OUTSIDE OF ANY PROJECT

BRACES

PVC COLUMNS

Hand crafted, factory seamed-columns provide a superior finish with no joint separation due to expansion. Our columns are manufactured with 100% PVC materials for low-maintenance and no rotting. They are engineered to withstand even the toughest elements.

We offer sleek designs and simple installation. All of our columns can be manufactured to any specification you may require.

**Columns can also be made from cedar*



S
N
M
U
T
O
C
C
O
L
U
M
N
S

CLASSIC COLUMNS

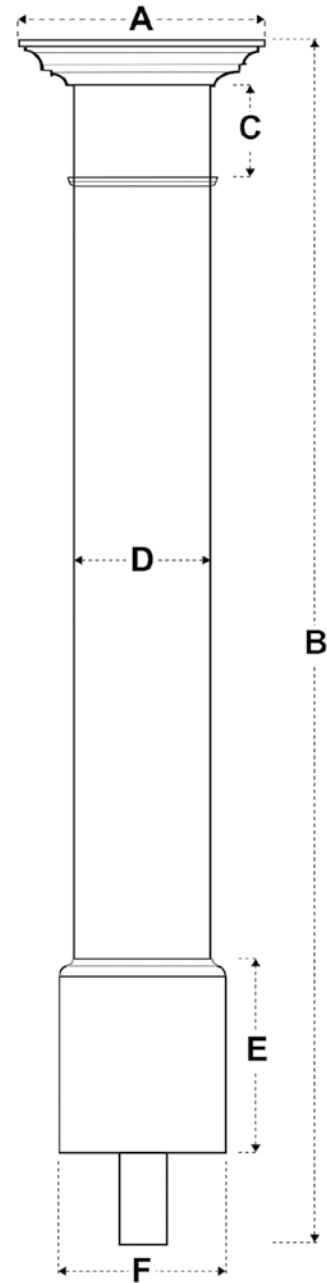
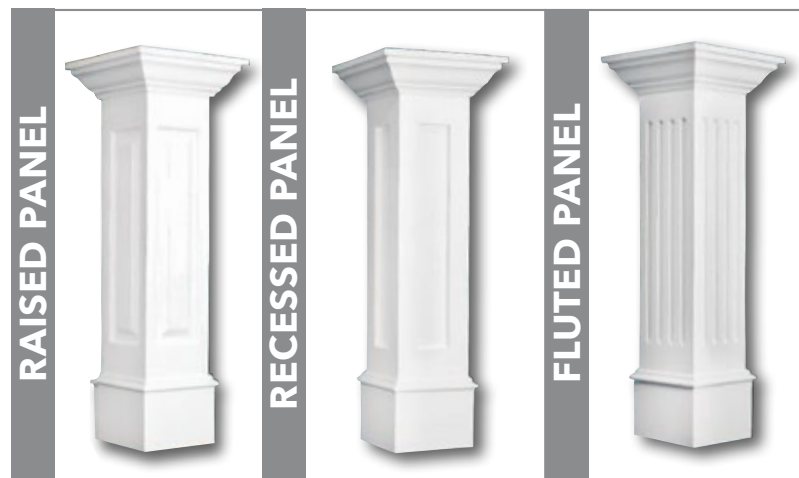

Classic Column Sizes	A	B	C	D	E	F
6" X 6" X 10'	10-5/8"	120"	6"	5-1/4"	12"	6-1/8"
8" X 8" X 10'	12-5/8"	120"	8"	7-1/4"	12"	8-1/8"
10" X 10" X 10'	14-5/8"	120"	10"	9-1/4"	12"	10-1/8"
12" X 12" X 10'	16-5/8"	120"	12"	11-1/4"	12"	12-1/8"

Available as a Half Column/Pilaster.

Structural Values Information

4X4 Center Post

#2 SYP Ground Contact

10' - 4,100 LBS.

12' - 2,900 LBS.

14' - 2,150 LBS.

6X6 Center Post

#2 SYP Ground Contact

10' - 12,700 LBS.

12' - 11,000 LBS.

14' - 9,150 LBS.

CLASSIC STYLE COLUMNS CREATE A DISTINCT AND ATTRACTIVE FINISHED LOOK, WHILE ADDING GREATER VALUE TO ANY HOME OR PROJECT. PERFECT FOR DRESSING UP ENTRANCES, PERGOLAS, PORCHES OR ANY NUMBER OF APPLICATIONS.

TAPERED COLUMNS

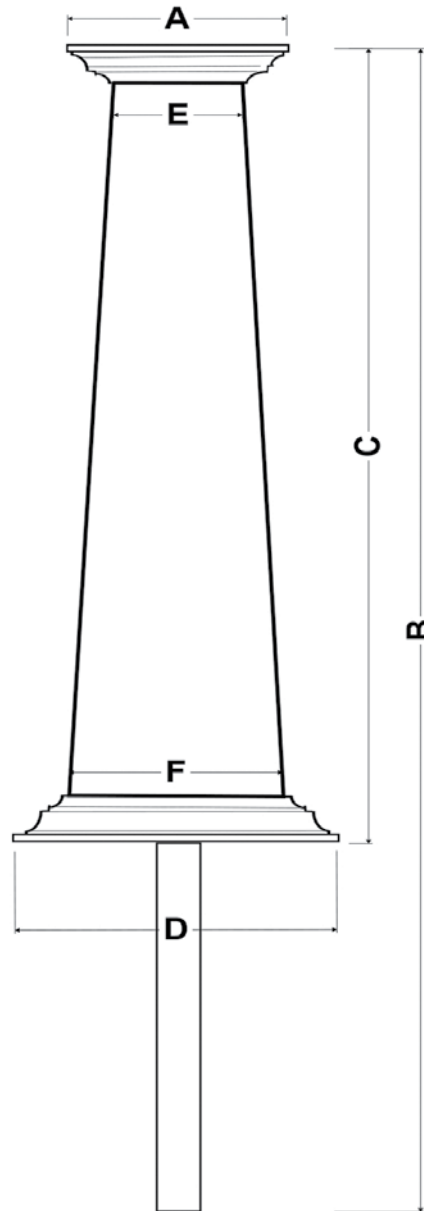
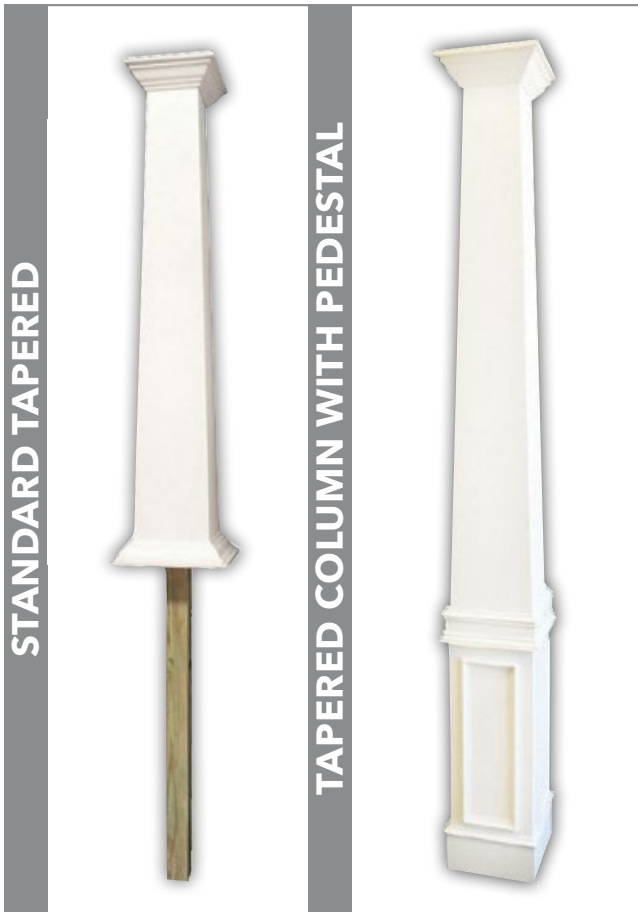

Tapered Column Sizes	A	B	C	D	E	F
6" X 10" X 72"	10-5/8"	120"	72"	14-5/8"	5-1/4"	9-1/4"
8" X 12" X 72"	12-5/8"	120"	72"	16-5/8"	7-1/4"	11-1/4"

Available as a Half Column/Pilaster.

Tapered Columns are available in Raised and Recessed Panels.

Structural Values Information

4X4 Center Post	6X6 Center Post
#2 SYP Ground Contact	#2 SYP Ground Contact
10' - 4,100 LBS.	10' - 12,700 LBS.
12' - 2,900 LBS.	12' - 11,000 LBS.
14' - 2,150 LBS.	14' - 9,150 LBS.



COLUMN WRAPS

Column wraps are available in both Classic and Tapered Column styles. Wraps can be custom made to fit your application.



ALREADY HAVE A POST
OR SUPPORT STRUCTURE
INSTALLED?

NO PROBLEM!

OUR UNIQUE REMOVABLE
HINGE ALLOWS EASY
INSTALLATION OVER ANY
POST OR BEAM. SIMPLY
SLIP THE COVER IN PLACE,
GLUE AND CLOSE THE
OPEN SIDE FOLLOWING THE
INSTALLATION INSTRUCTIONS.
THEN ADD THE PRECUT
TRIM PIECES FOR A CUSTOM
FINISHED LOOK!



GABLE VENTS

Designed to be both beautiful and functional, gable vents (or louvers) have been used as design accents. We offer two basic types: functional (venting) and decorative (non-venting). They come in a multitude of materials and shapes to fit most architectural styles. Unlike other passive venting systems, such as soffit or ridge vents, gable vents are meant to be seen. They are made visible in the front of a building and add an architectural element to an otherwise invisible opening.

**Vent materials: cedar, PVC, pine and primed*

SEGMENT TOP



PITCH TOP



HALF ROUND



RECTANGLE



TRIANGLE

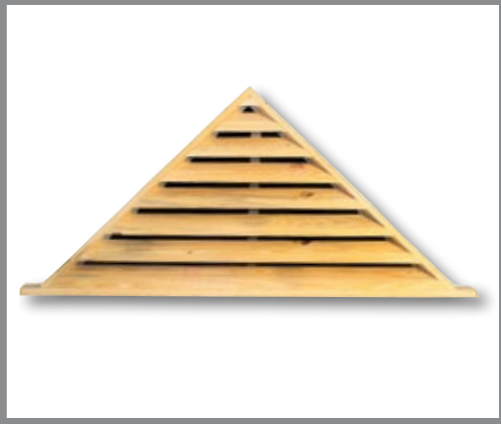

*MANY POSSIBLE
OPTIONS ARE
AVAILABLE TO GO
WITH THE DESIGN
OF THE HOMES.
CUSTOM DESIGNS
ARE AVAILABLE
UPON REQUEST.*

Round Top

Width

Half Round

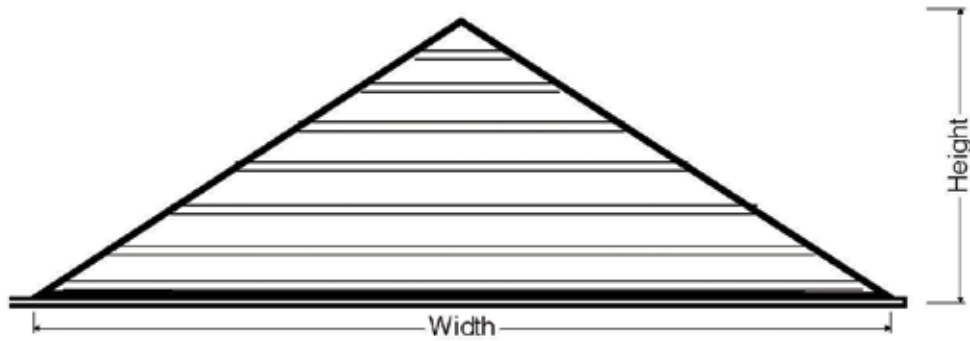

Pitch and Base

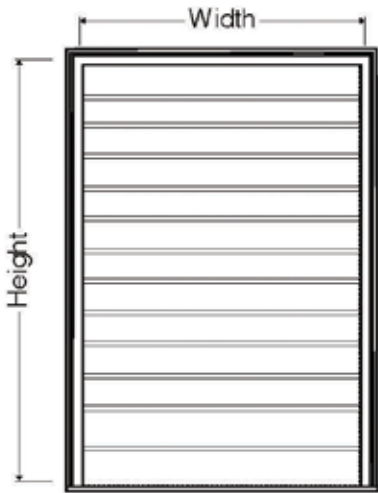

Rectangle

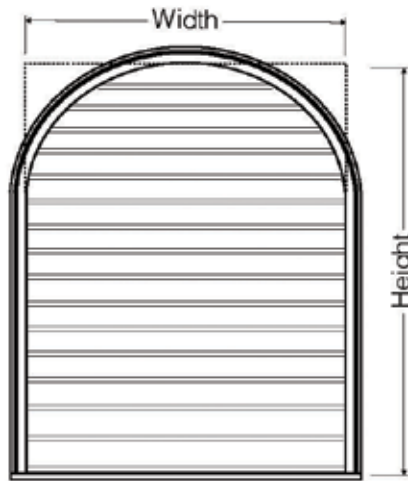

Round Top

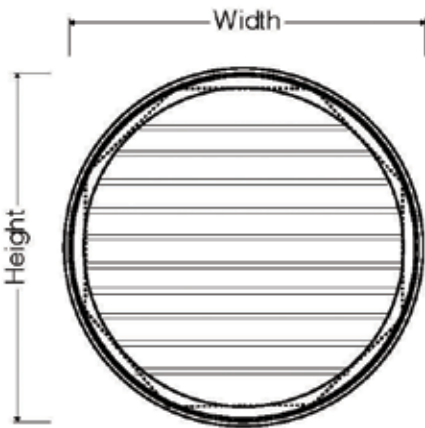

Round

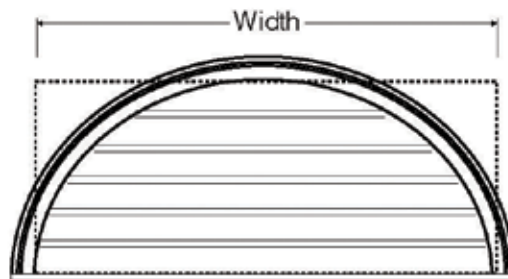

Half Round

VENT MATERIALS-
CEDAR, PVC, PINE AND PRIMED

GABBLE VENT

STYLES

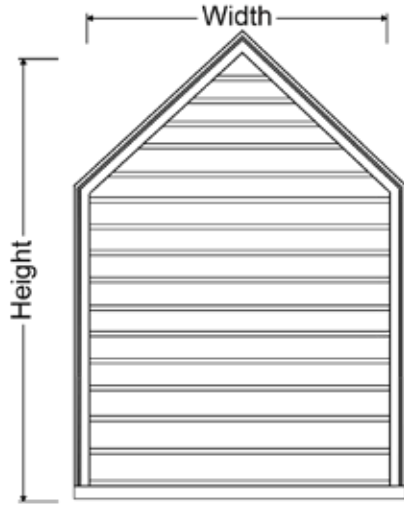

Pitch Top

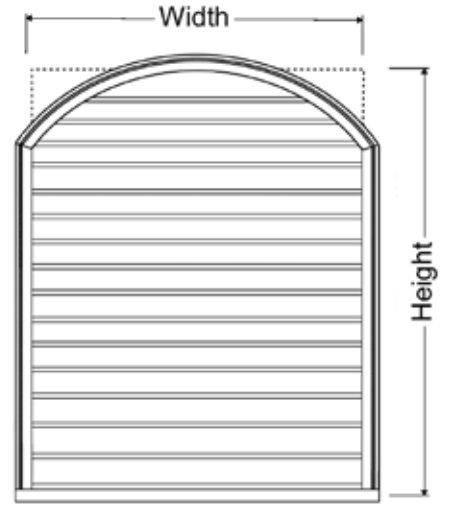

Segment Top

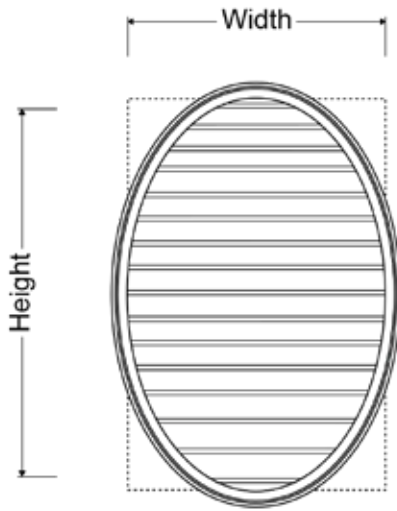

Oval

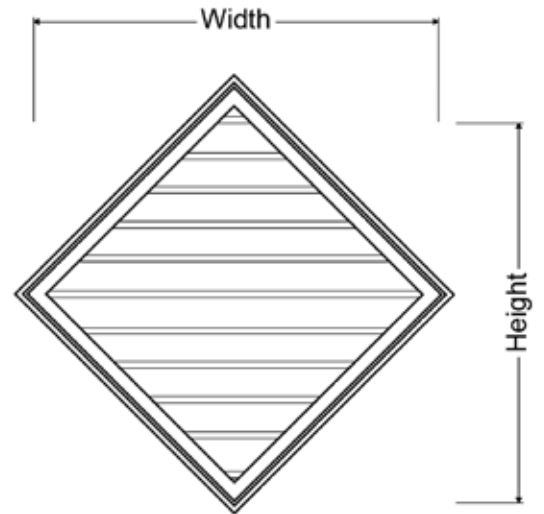

Diamond





SHUTTERS

The right exterior shutter can reflect your own distinctive style and dramatically increase your home's curb appeal. It is the first thing you and your visitors see. With a wide variety of styles in standard and custom sizes, we can help you create that exciting "Welcome Home" moment, with custom shutters by Jeriel Products.

HAND CRAFTED SHUTTERS

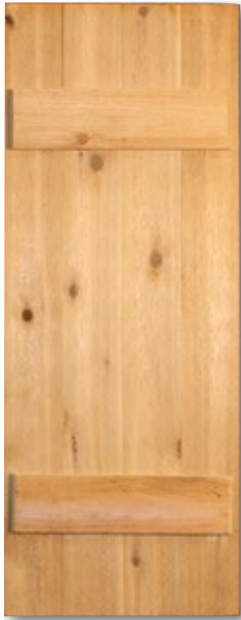

Available in Composite, Cedar, Cypress and Eastern White Pine



SHUTTER STYLES INCLUDE

2 Bar
3 Bar
Z Bar
V-Groove
Raised Panel

STANDARD SHUTTER SIZES

38"- below 3/0
39"-47" 3/0-3/6
48"-57" 4/0-4/6
58"-67" 4/6-5/2
68"-83" 5/2-6/2



JERIEL PRODUCTS PROVIDES ARCHITECTURAL COMPONENTS THAT ADD DISTINCTION AND VALUE TO YOUR PROJECT. ALL OUR PRODUCTS ARE CUSTOMIZABLE AND AVAILABLE IN A VARIETY OF MATERIALS AND FINISHES. BY UTILIZING STATE OF THE ART EQUIPMENT AND PRODUCTION METHODS, WE ARE ABLE TO DELIVER QUALITY ITEMS AT A REASONABLE COST. CONTACT US TODAY WITH YOUR NEEDS AND LET US WORK WITH YOU TO DELIVER A STYLISH SOLUTION TO YOUR NEXT BUILDING PROJECT. WE LOOK FORWARD TO WORKING WITH YOU.



JERIEL PRODUCTS

770.445.2389

jerielproducts.com