

AZEK[®]
EXTERIORS

ENGINEERED TO LAST BEAUTIFULLY

PREMIUM TRIM & SIDING

TRIM | SIDING | MOULDING | FASTENING





THE PROS' #1 CHOICE

AZEK Exteriors Siding, Trim, Moulding, and TimberTech Cladding beautifully wrap a home's entire exterior from roofline to ground contact. The advanced polymers (PVC) used in our products are incredibly durable and need virtually no maintenance. And since moisture, rot, insects, and mold are not an issue, we back our products with a Lifetime Limited Warranty.



THE PROS' #1 CHOICE	2
Material advantage	4
Superior performance	6
Smart solutions	8
Installation ease	10
Finishing choices	12
Sustainability	14
SIDING	16
Shingle	19
Bevel	21
Board and Batten	23
Cladding	26
Collections	29
Advantages	30
Specs	32
TRIM/MOULDING/SPECIALTIES	34
Advantages	36
Trim, Sheet, ATM	38
Flanged, Cornerboards	40
Skirt Boards	42
Beadboard/Shiplap	44
Column Wraps	46
J-channel	48
Soffit systems	50
Cortex®	51
Alpine Collection	52
Moulding profiles	54
Adhesives/accessories	58



RESISTS MOISTURE & ROT

AZEK Trim and Siding does not deteriorate, swell, or splinter with moisture like wood or fiber cement.



INSTALLS EASILY & EFFICIENTLY

Smart solutions, familiar tools, intuitive techniques, and AZEK support boost your productivity.



ENDURES BEAUTIFULLY

With real wood beauty and none of its downsides your projects will look great and last for decades.

ADVANCED MATERIAL, SUPERIOR PRODUCTS BEAUTIFUL NOW AND FOR DECADES

Our premium products are made from PVC using advanced materials science and crafted for installation ease. With moisture resistance and durability far superior to traditional wood and other non-wood alternatives, AZEK® ensures that years from now your installation will look as beautiful as on day one.

MOISTURE RESISTANT

AZEK boards are 100% protected, inside and out, from both water exposure and absorption.

UNPRECEDENTED DURABILITY

Our flexible and durable engineered polymer prevents jobsite breakage and delivers long-lasting protection for homeowners.

ROT RESISTANT

No splitting, splintering, and rotting caused by exposure to the elements. Wood rots, AZEK does not.

UNIFORMITY

No knots, no finger joints, no dimensional inconsistencies. Let your designs vary, not your boards.

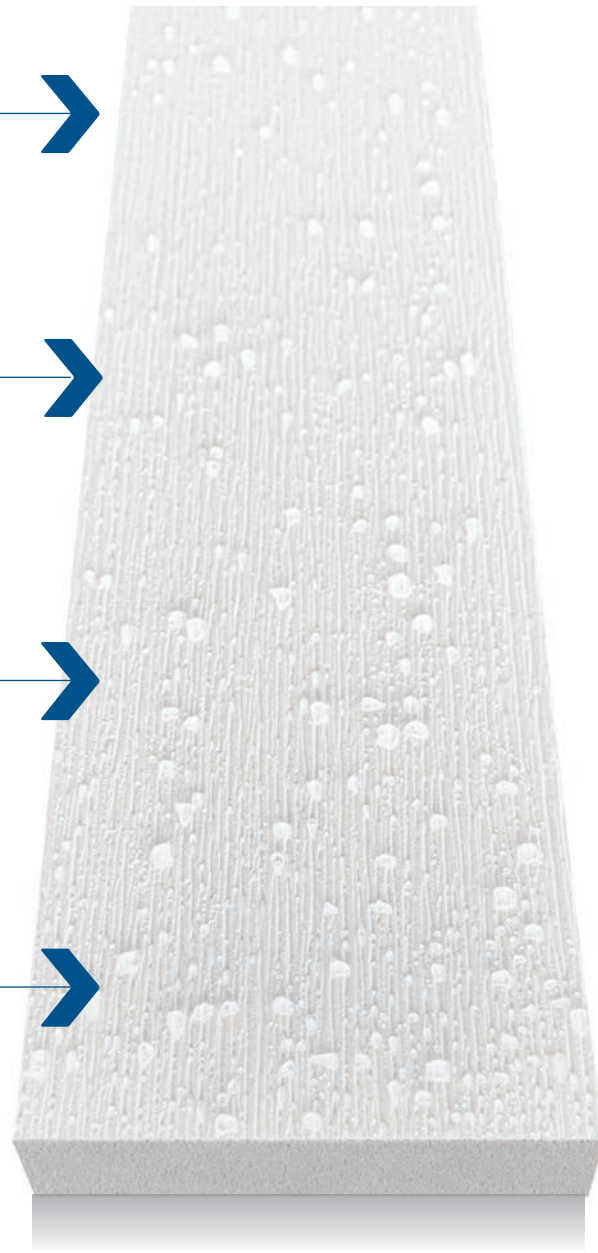

Moisture Resistant



Rot Resistant



Insect Resistant



Weather Resistant



Durable, Less Long-Term Maintenance



Lightweight



Fire Resistant



INDUSTRY-LEADING WARRANTIES

We back the performance of our trim, moulding, and siding with a Lifetime Limited Warranty that covers rotting, delaminating, splintering, and swelling from excessive moisture.



CLASS A FLAME SPREAD RATING

AZEK's top-rated fire resistance means slower flame spread in a fire than traditional wood and composite materials, making our top-rated products a smart choice for building in fire zones.

WHERE OTHER MATERIALS FAIL, WE PREVAIL

AZEK OUTPERFORMS WOOD, FIBER CEMENT, AND ENGINEERED WOOD



PAINTED WOOD
Paint needs constant repainting.



ENGINEERED WOOD
Unsealed ends? Rot is coming.



FIBER CEMENT
Cracks open the way for water infiltration.



PAINTED WOOD
Moisture cycles destroy wood.



ENGINEERED WOOD
Rot starts small and grows up.



FIBER CEMENT
Ground contact? Not for long.

MOISTURE IS A HOME'S WORST ENEMY

Wood and other porous materials naturally absorb water even when painted. This leads to rot, mold growth, and material expansion. As trim or siding expands, the resulting movement can lead to unsightly damage and leave extended gaps in the exterior wrap, making other parts of the home susceptible to water damage.

AZEK REPELS WATER THAT OTHERS ABSORB

We submerged siding materials for 100 days, and AZEK PVC absorbed almost nothing, while other materials absorbed a high percentage of their weight in water.

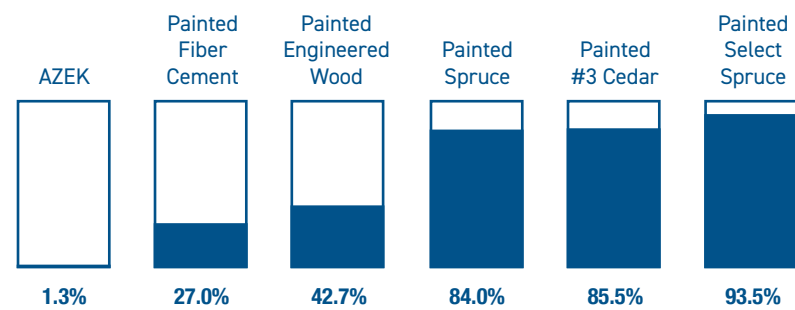

"The yacht club is the first thing you see when you come down the channel from the big lake. The project has been a huge success. And all the AZEK product has been a part of it."

Joe Guenther, Commodore,
Pentwater Yacht Club

SOLUTION PROFILES HELP YOU WORK SMARTER



UNIVERSAL SKIRT BOARD

The perfect transition between siding and grade with no starter strips needed.

See page 42.

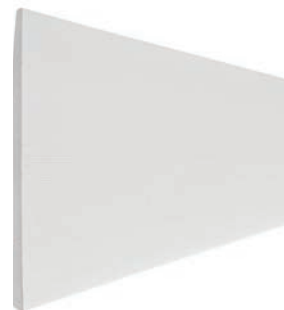

BEVEL SIDING

Bevel Siding is the most authentic-looking cedar siding replacement with the low-maintenance performance of rot-proof PVC.

See page 20.



ONE-PIECE COLUMN WRAP

One piece of PVC material wraps a wood post for perfect corners and great aesthetics. Glue seams, attach, and trim out as you desire.

See page 46.

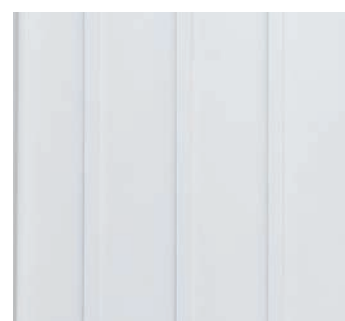

BOARD AND BATTEN

Available in Classic White or with PaintPro Technology, AZEK B&B offers more options in batten width and spacing for ultimate design flexibility.

See page 22.

INTEGRATED DRIP EDGE OR ONE-PIECE SKIRT BOARD

Designed for water management around doors and windows, it's also ideal for band board installations.

See page 43.



AZEK offers more trim sizes, siding, and solution-based moulding profiles than any other brand on the market. Our engineered polymer products deliver the exterior solution you need and your project deserves.



FLANGE SLOTTED TRIM, RABBETED TRIM, AND J-SERIES J-CASING

Trim boards are designed to reduce installation time and create beautiful window and door surrounds.

See page 40.



STRAIGHT AND STAGGERED SHINGLE SIDING

AZEK Shingle Siding is available in three sizes, all with PaintPro® Technology.

See page 18.



J-SERIES QUICK CORNER™ OUTSIDE CORNER

One-piece corner boards install quickly with no caulk required and no unsightly edges.

See page 49.



EXPLORE AZEK SIDING

ENGINEERED FOR THE INSTALLER

AZEK INSTALLS EASILY AND QUICKLY WITH THE TOOLS YOU KNOW

We work hard to make the installer's job easier, because we know you're working hard to make the homeowner happy. Our solutions mean less on-site fabrication, smoother transitions between material types, less waste, and boards that cut like butter. The bottom line: fewer callbacks.



LIGHT AND EASY TO HANDLE

From unloading the truck to moving at the worksite, AZEK's manageable weight saves time and trips. Spend more time working, not carrying.



LESS BREAKAGE, MORE FLEXIBILITY

AZEK bends. Other materials break. You won't buy extra to account for jobsite breakage. Bonus: curved and arched applications are easy.



SAME TOOLS—AND NO RESPIRATOR

Regular woodworking tools—including saw blades—work fine with AZEK. Cuts won't make a cloud of dust needing a silica respirator.



GROUND CONTACT APPROVED

Water has no effect on AZEK's beauty, performance, or durability. Install it at ground level, by sprinklers, or where the snow piles up without worries.



NO GRAIN, NO KNOTS, LESS SPLITTING

Splinter-prone wood and crumbly fiber cement lead to wasted boards. Dense AZEK boards aren't likely to split even when nailing near ends.



SOLUTION PROFILES MEAN LESS FABRICATION

Smart solutions save time and perform better than on-site builds. Soffit and fascia, starter boards, column wraps, cornerboards, and more keep your project moving.



THE BOARD
A LOYALTY PROGRAM BY AZEK

Join The Board™ and start earning with every TimberTech®, AZEK® Exteriors, and StruXure® installation. Redeem points for marketing, training, or cash, and begin benefiting immediately upon joining.



JOIN THE BOARD TODAY

"We use AZEK window casing, door casing, corner trim, soffits, and siding. The continuity of their products is really unbeatable."

Adam Diamond-Contractor
Diamond Home Restoration



CLASSIC WHITE

BRILLIANT WHITE TODAY AND ALWAYS

AZEK® Classic White is the trim that started it all. For 25 years, we've put an end to trimboards that rot or need repainting every few years. Our legacy of moisture protection, curb appeal, and low maintenance is still going strong today.

NO PAINT NEEDED

A crisp, semi-matte white finish creates the classic trim and moulding look without painting. While Classic White can be painted, a PaintPro board will hold paint even stronger and dry faster.

LOW MAINTENANCE FOR LIFE

Unaffected by moisture, deterioration, and rot the way other materials are, AZEK Classic White keeps its pristine appearance without ongoing effort.

LESS FADING & YELLOWING

AZEK uses high amounts of titanium pigments to ensure a long-lasting white. Other brands may skimp on costly pigments, leading to yellowing with age.



PAINTPRO TECHNOLOGY

THE BEST SUBSTRATE FOR PAINT

AZEK Trim and Siding with PaintPro® Technology helps create a superior bond with paint for improved coverage without the need for any special prep. PaintPro Technology helps ensure longer-lasting curb appeal. With the revolutionary power of PaintPro-enhanced for exterior trim and siding, there's no need for frequent maintenance and expensive repainting.

READY TO PAINT

No sanding. No priming. Faster dry times.

SUPERIOR ADHESION

Paint creates a strong bond to reduce chipping, cracking, and other paint defects over time.

LOW MAINTENANCE

Enjoy a painted finish that endures beautifully without the need for constant repainting.



PAINTPRO
PAINTING
GUIDELINES



PREFINISHED SIDING & TRIM NOW AVAILABLE

Get any PaintPro profile prefinished for the ultimate in convenience. Available regionally, our partners factory-paint your order using top-quality paints that follow all AZEK guidelines. Your job moves faster and your finish is better than any field-painted project.



CHECK REGIONAL
AVAILABILITY

PVC SUBSTRATE

Impervious to rot and water damage.

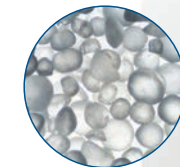

PAINTPRO TECHNOLOGY

No priming needed. Paint adheres stronger than with untreated PVC.

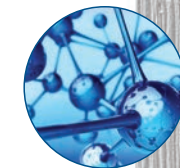

PREMIUM PAINT

The right paint, pigments, and formulas; factory applied for a high performance finish.

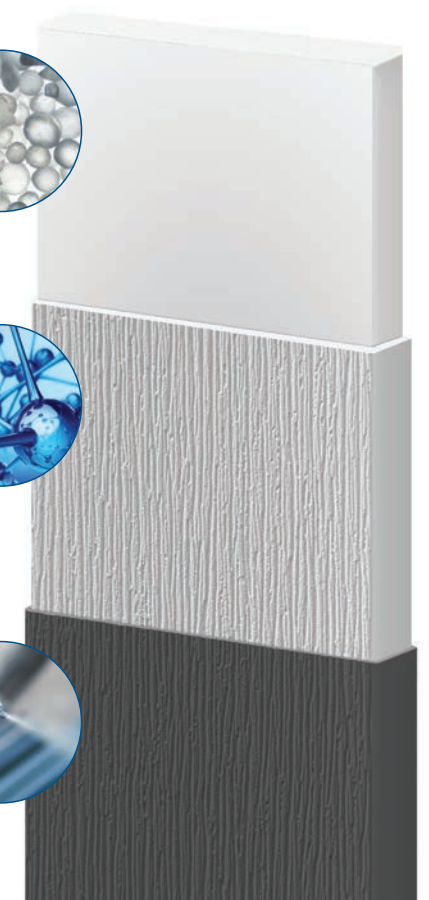



JOIN US IN CREATING A MORE SUSTAINABLE FUTURE

As the innovative manufacturer of beautiful, low-maintenance, environmentally sustainable exterior building products, AZEK® is deeply committed to making a lasting impact on the world by accelerating the use of recycled materials. We pursue initiatives that positively impact our products, our industry, and our planet. Leveraging our R&D strengths, we introduce products that increasingly utilize recycled materials. We're working to meet our own ambitious targets, like using one billion pounds of recycled waste and scrap material annually in the manufacturing of our products.

2.1 BILLION LBS of waste and scrap diverted from landfills and oceans since 2019

1,200+ of our AZEK FULL-CIRCLE PVC RECYCLING® bins are located at sites and across the U.S., collecting and repurposing post-consumer materials and post-industrial PVC scrap



GOODS THAT DO GOOD

AZEK offers many high-quality products made from as much as 95% post-consumer and post-industrial recycled materials.



WE GET SCRAPPY

AZEK FULL-CIRCLE RECYCLING® reduces jobsite waste, saves on construction landfill disposal costs, and gives homeowners a more sustainable home.



PVC SCRAP RECYCLE BIN PROGRAM

As a part of the AZEK FULL-CIRCLE PVC RECYCLING® Program, we are partnering with our network of dealers and distributors to offer recycle bins to collect PVC trim, siding, and cladding scrap. Contractors can request FREE bins from participating dealers — including drop off and pick up — to collect jobsite scraps, reduce associated landfill fees, and make an environmental impact in their market.

GET INVOLVED FOR ZERO COST

- Find recycle bin locations in your area
- Get set up with bins at your dealer location
- Inquire about FREE bins at an actual jobsite



START RECYCLING PVC

The AZEK Company is a Gold member of the U.S. Green Building Council and is pleased to support project teams working to attain LEED certification. AZEK's Chicago headquarters are LEED certified. For details about how AZEK supports LEED certification, review our LEED playbook.

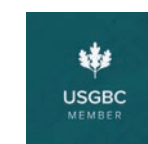

AZEK LEED PLAYBOOK

Effortless beauty,
superior durability



SIDING WITH PAINTPRO TECHNOLOGY

AZEK® Siding options achieve best-in-class aesthetics with the performance and low-maintenance benefits of rot-proof PVC building materials. Using exclusive PaintPro® Technology, AZEK Shingle and Board & Batten offer rapid paint dry times, superior paint adhesion, and a painted finish that lasts without needing frequent maintenance. Bevel siding's proprietary technology means it's ready to accept paint without any surface prep or priming. Delivering and installing enduring beauty with superior durability has never been so effortless.



Moisture Resistant



Rot Resistant



Insect Resistant



Weather Resistant



Durable, Less Long-Term Maintenance



Lightweight



Engineered for Paint



Fire Resistant



SHINGLE SIDING

NATURAL HAND-CRAFTED APPEARANCE

AZEK® Shingle Siding delivers an authentic and timeless cedar shake look. State-of-the-art proprietary engineered polymers deliver superior endurance, durability, and rot resistance. Get the classic look of cedar siding with enhanced endurance and moisture resistance, no matter the climate. Enhanced with PaintPro Technology, AZEK Shingle Siding enables a long-lasting painted finish without the frequent maintenance. Available in three profiles. *See page 24.*



STRAIGHT SHINGLE 7" AND 5" REVEAL

Consistency with a dash of variety. Uniform horizontal lines with varied width tabs and keyways for the most natural-looking shingle to beautifully complement contemporary or classic exterior architecture.

STAGGERED SHINGLE 6" REVEAL

Patterns with individual character, dimension, and diversity. Each random-edge panel enhances the overall pattern for an amazing exterior façade with variety in vertical and horizontal lines.





BEVEL SIDING

SEAMLESS CEDAR REPLACEMENT

AZEK® Bevel looks so much like real cedar siding, that it can repair and replace rotted cedar boards seamlessly. And when Bevel wraps an entire house, rot is a thing of the past. Installs easily with face nailing and without knots or finger-joints. Prepped and ready to paint without priming, AZEK Bevel creates a traditional look with the freedom of low maintenance. See page 25.



Smooth, Brushed Finish



BOARD AND BATTEN SIDING MORE DESIGN OPTIONS

Traditionally, board and batten siding starts with wide vertical planks (boards), which are then joined together by thin vertical strips (battens) to cover the seams. Using AZEK® Sheet as the board and AZEK Trim as the batten, design options multiply. Narrow battens or wide, close spacing or broad, your design is no longer locked in to a specific size. AZEK Sheet and Trim used in board and batten is available in Classic White or with ready-to-paint PaintPro® Technology. See page 25.



TRADITIONAL NARROW SPACING

The spacing of board and batten used to be determined by the width of the boards. The boards most common width was 8", which led to the traditional narrow spacing. Narrow batten placement at 8" or 12" works well on smaller, more compact exterior spaces.



ACCENT AND WIDE-WIDTH SPACING

With the popularity of the modern farmhouse design, batten spacing of 12" to 16" may be desired to enhance the modern approach and create a less cluttered look, especially on larger spans of siding.



PRODUCT DETAILS AND TECHNICAL SPECS

SHINGLE SIDING

SHINGLE SIDING	
7" Reveal Straight-Edge Shingle Panel	48" x 16" x 1/4"
6" Reveal Staggered-Edge Shingle Panel	48" x 15" x 1/4"
5" Reveal Straight-Edge Shingle Panel	48" x 12" x 1/4"

7" REVEAL STRAIGHT-EDGE SHINGLE PANEL

(43 panels per square)

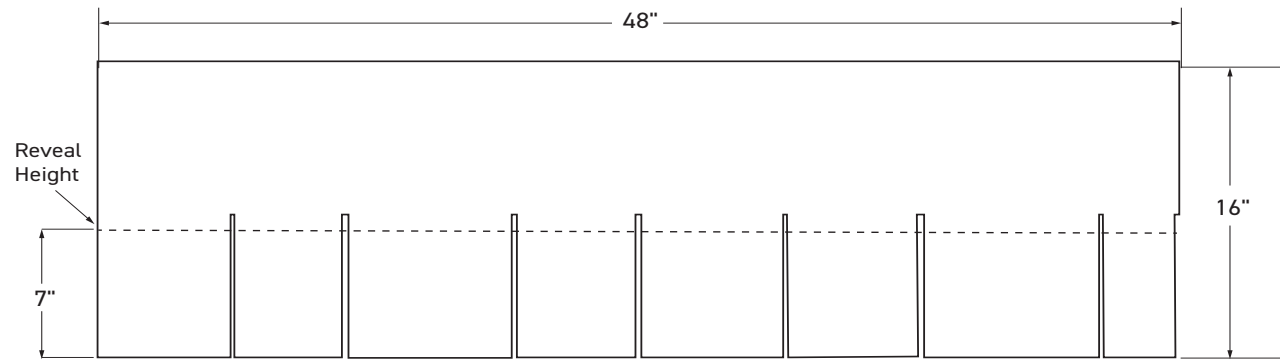

6" REVEAL STAGGERED-EDGE SHINGLE PANEL

(50 panels per square)

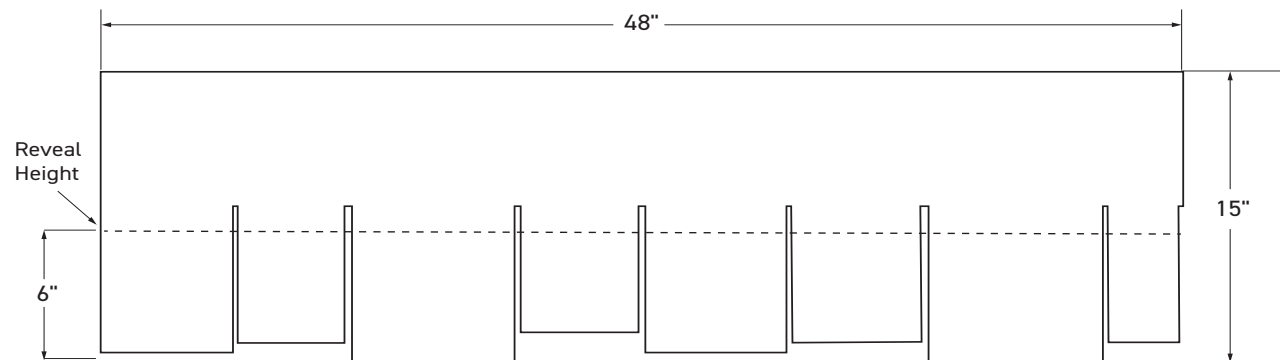

5" REVEAL STRAIGHT-EDGE SHINGLE PANEL

(60 panels per square)

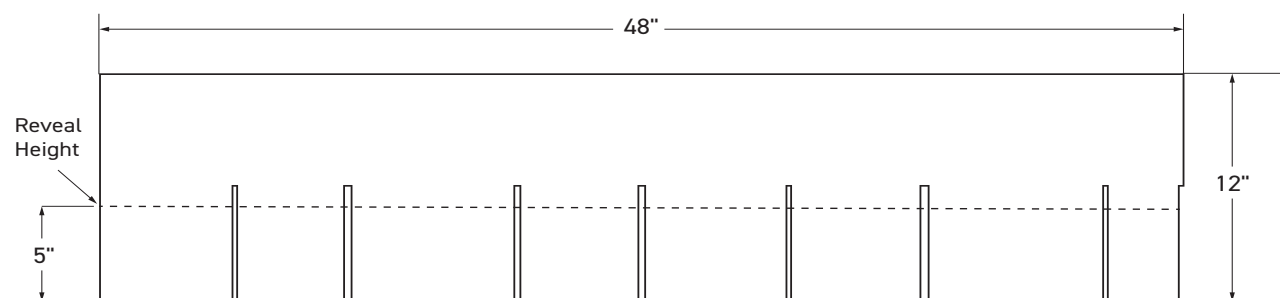

BOARD AND BATTEN SIDING

PAINTPRO TECHNOLOGY
BOARD AND BATTEN

SHEET OPTIONS	
1/2" x 48" x 8'	Reversible Texture (Woodgrain/Smooth)
1/2" x 48" x 10'	Reversible Texture (Woodgrain/Smooth)
1/2" x 48" x 12'	Reversible Texture (Woodgrain/Smooth)
BATTEN OPTIONS	
3/4" x 1.5" x 16'	Reversible Texture (Woodgrain/Smooth)
3/4" x 2.5" x 16'	Reversible Texture (Woodgrain/Smooth)



SHEET (ALL REVERSIBLE SMOOTH/WOODGRAIN)

1/2" x 4' x 8' (Classic White or PaintPro)	1/2" x 4' x 10' (Classic White or PaintPro)
1/2" x 4' x 12' (Classic White or PaintPro)	

CLASSIC WHITE
BOARD AND BATTEN

SHEET OPTIONS	
1/2" x 48" x 8'	Reversible Texture (Woodgrain/Smooth)
1/2" x 48" x 10'	Reversible Texture (Woodgrain/Smooth)
1/2" x 48" x 12'	Smooth
BATTEN OPTIONS	
3/4" x 1.5" x 18'	Reversible Texture (Woodgrain/Smooth)
3/4" x 2.5" x 18'	Smooth



TRIM

3/4" x 1 1/2" x 16' PaintPro (Reversible)
3/4" x 2 1/2" x 16' PaintPro (Reversible)
3/4" x 1 1/2" x 18' Classic White (Woodgrain/Smooth + Reversible)
3/4" x 2 1/2" x 18' Classic White (Woodgrain/Smooth + Reversible)

BEVEL SIDING

BEVEL SIDING		
Dimensions	Reveal	Length
5.25" x 7/16"	4"	12'

4" REVEAL BEVEL BOARD
(25 boards per square)

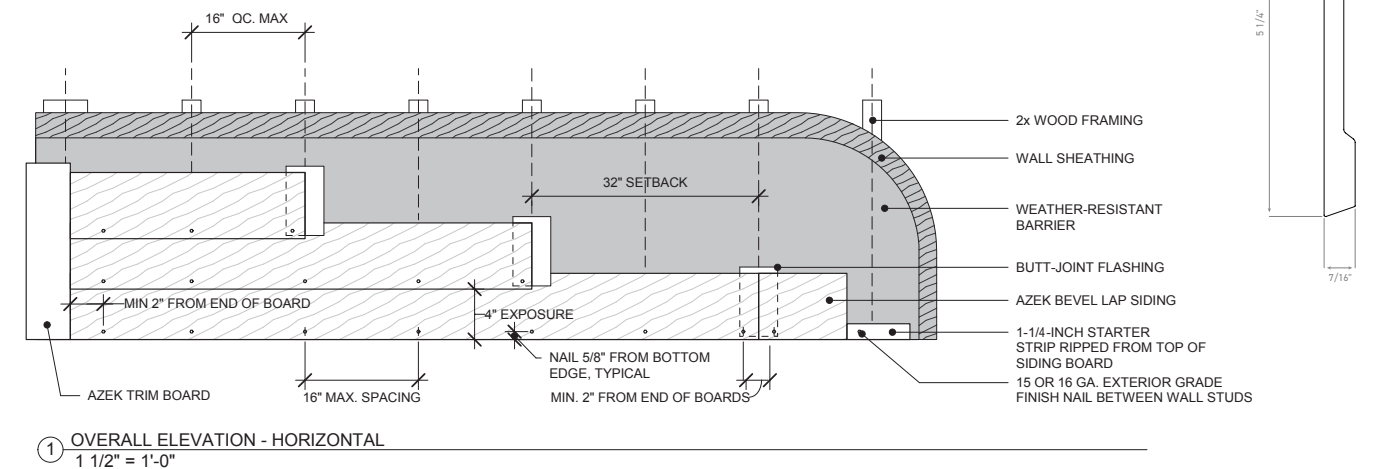

① OVERALL ELEVATION - HORIZONTAL
1 1/2" = 1'-0"

Real-wood looks, high-tech performance

TimberTech
PVC CLADDING
BY AZEK



TimberTech
Vintage® Collection®
In English Walnut®,
Mahogany and Coastline®

TIMBERTECH CLADDING

AZEK Exteriors® joins with the power of TimberTech® to offer Advanced PVC Cladding that delivers the full aesthetic experience of wood without the laborious, costly, and constant upkeep required with traditional lumber. TimberTech's one-of-a-kind polymer boards use technology and artistry to achieve a hyper-realistic wood look that lasts. Plus, our cladding has a Class A Flame Spread Rating and WUI Compliance, making it a smart choice in fire zones. An inspiring variety of colors, finishes, widths, and profiles open a world of design possibilities, while industry-leading warranties build confidence.



Moisture Resistant



Rot Resistant



Insect Resistant



Weather Resistant



Durable, Less Long-Term Maintenance



Lightweight



Fire Resistant



Timbertech® Vintage Collection® in Mahogany
 5.5" Square-Shoulder Board

VINTAGE COLLECTION® CLADDING

Exotic Hardwoods

The Vintage Collection is defined by natural-looking colors that mimic the look of ipe, teak, and other hardwoods. A subtle wire-brushed, low-gloss finish gives this elegant collection a truly authentic and sophisticated look. Unique board widths (narrow, standard, and wide) further open design possibilities.



COASTLINE®



WEATHERED TEAK®



MAHOGANY



ENGLISH WALNUT®



DARK HICKORY



CYPRESS®

LANDMARK COLLECTION® CLADDING

Crosscut Hardwoods

The Landmark Collection resembles popular hardwoods that have been crosscut for character-rich texture. Cascading colors define board-to-board color variation, ranging from dark, freshly stained walnut to the muted gray ambiance of weathered wood. Like all TimberTech Cladding, Landmark's distinctive grain and matte finish is fade resistant and needs no special maintenance.



CASTLE GATE™



AMERICAN WALNUT®



FRENCH WHITE OAK®



BOARDWALK®

WITH INCREDIBLE VERSATILITY YOUR DESIGNS SOAR

With an unmatched portfolio of diverse colors, woodgrain patterns, and board widths, the design potential with TimberTech® Cladding is nearly limitless. Using moisture- and fade-resistant Advanced PVC technology, our TimberTech Cladding boards protect the integrity of your exterior design for years to come. Build on the rich hues and textures of TimberTech Cladding to highlight an entryway, add design detail to a porch, or as one element among mixed building materials for a clean, dimensional finish.

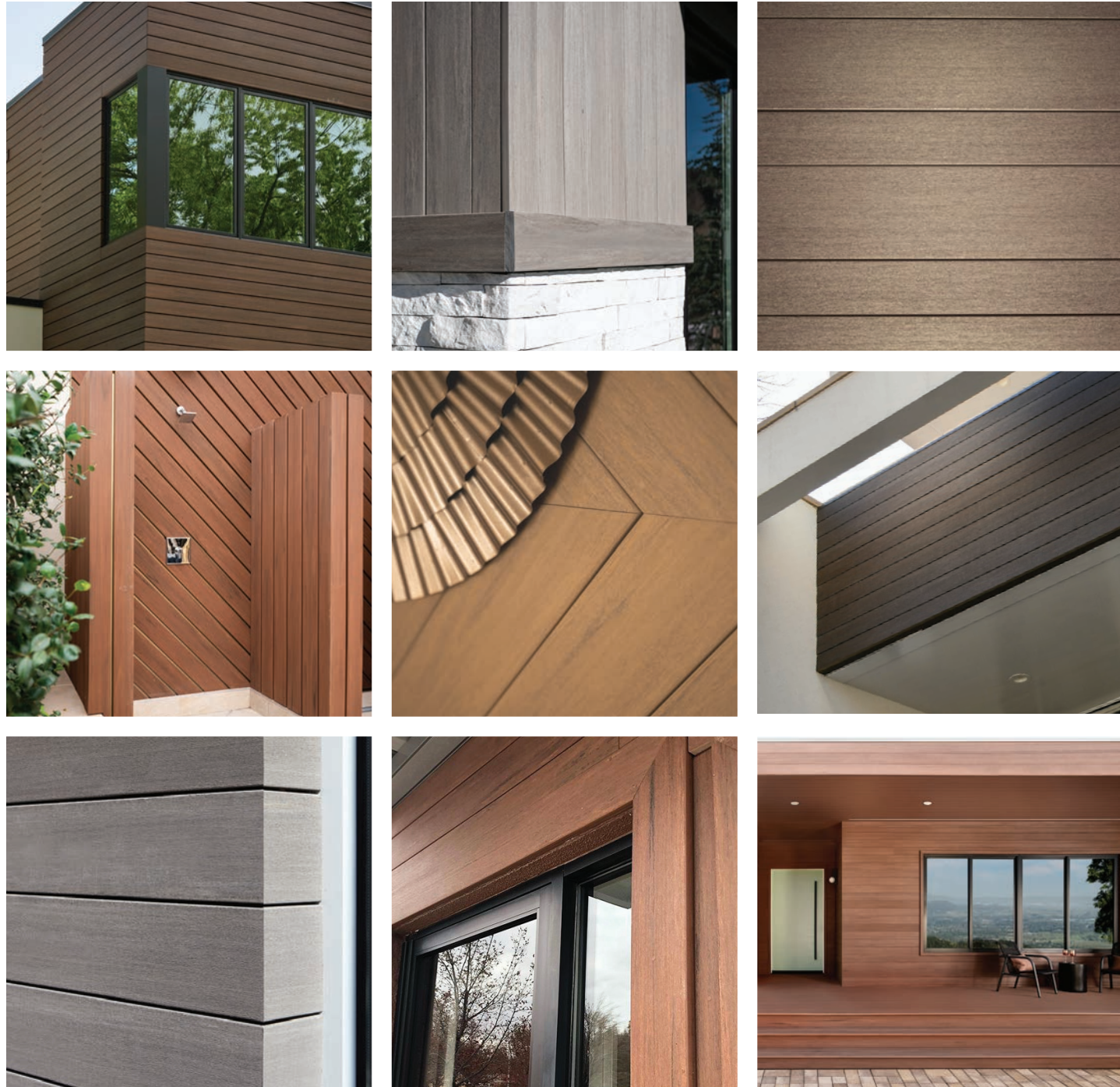

APPLICABLE FOR RESIDENTIAL & COMMERCIAL

TimberTech® Cladding is the only PVC cladding brand in the industry that offers tongue-and-groove (closed-joint) cladding and square-shouldered (open-joint) cladding. Approved for and warranted in commercial, residential, and multifamily projects, our cladding offers both extreme durability and ultra-low maintenance.

RESIDENTIAL WARRANTIES

TimberTech Advanced PVC Cladding is backed by an industry-leading Lifetime Limited Warranty and 50-year Fade & Stain Limited Warranty.



COMMERCIAL WARRANTIES

Bring the enduring beauty of TimberTech Cladding to your commercial builds with the confidence guaranteed from durable, low-maintenance materials and industry-best performance.



FIRE RESISTANCE

The TimberTech Vintage Collection® and Landmark Collection® have a Class A Flame Spread Rating, the best available. This means that in a fire, flames will spread slower across the material surface. These collections are also WUI (Wildland Urban Interface) Compliant for both open-joint and closed-joint installations.



GET FREE CLADDING SAMPLES



TONGUE-AND-GROOVE

SQUARE-SHOULDERED

PRODUCT DETAILS AND TECHNICAL SPECS

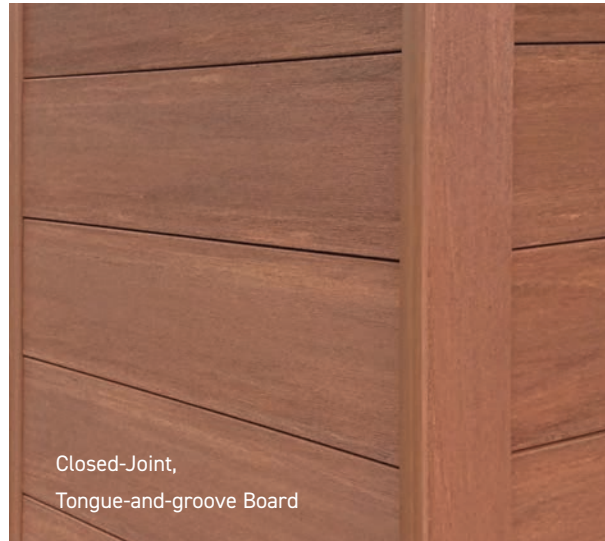

Closed-Joint, Tongue-and-groove Board

CLOSED-JOINT CLADDING

Sometimes referred to as “closed-joint,” tongue-and-groove boards interlock together with ease, creating a solid barrier with a neat, smoothly finished look without gaps.

Tongue-and-groove board sizes:

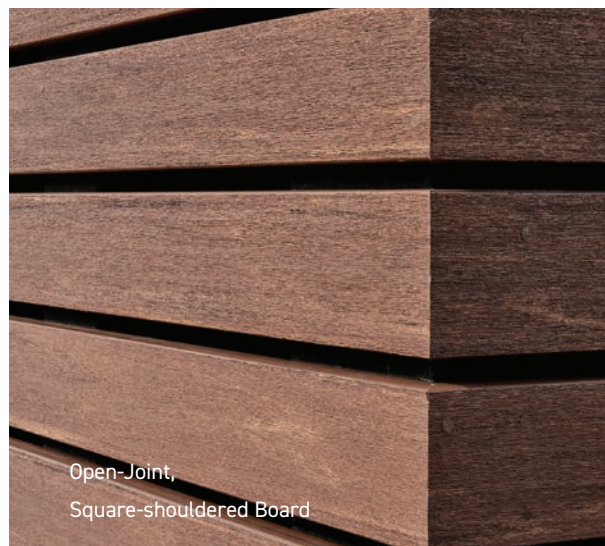

Open-Joint, Square-shouldered Board

OPEN-JOINT CLADDING

The open joints between the cladding elements create a strong, linear design pattern while also functionally providing ventilation for proper air circulation.

Square-shouldered board sizes:

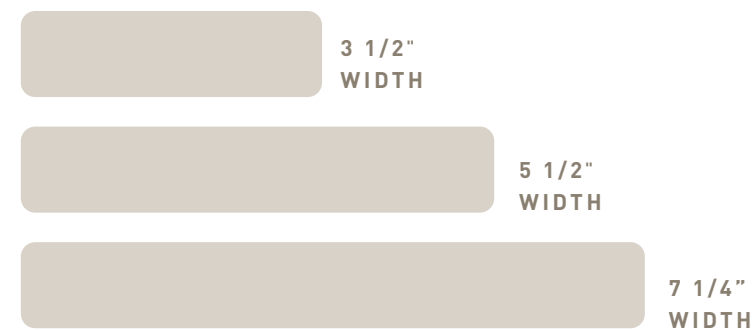

TONGUE-AND-GROOVE	WIDE WIDTH 5 1/2"		STANDARD WIDTH 3 1/8"	
Standard Thickness 1"	12'	16'	12'	16'
COASTLINE®	•	•	•	•
WEATHERED TEAK®	•	•	•	•
MAHOGANY	•	•	•	•
DARK HICKORY	•	•	•	•
ENGLISH WALNUT	•	•	•	•
CYPRESS	•	•	•	•



SEE FOR YOURSELF,
ORDER A FREE SAMPLE TODAY



SQUARE-SHOULDERED	NARROW WIDTH 3 1/2"	STANDARD WIDTH 5 1/2"	WIDE WIDTH 7 1/4"
VINTAGE Standard Thickness 1"	12' & 16'	16'	12' & 16'
COASTLINE®	•	•	•
WEATHERED TEAK®	•	•	•
MAHOGANY	•	•	•
DARK HICKORY	•	•	•
ENGLISH WALNUT	•	•	•
CYPRESS	•	•	•
LANDMARK Standard Thickness 1"	16'	16'	16'
FRENCH WHITE OAK		•	
CASTLE GATE		•	
AMERICAN WALNUT		•	
BOARDWALK®		•	

The cladding applications depicted in this brochure are for display purposes only and not for the purpose of validating the suitability, warrantability, or safety of any particular installation or application of the product. Always consult AZEK's Installation Instructions to ensure proper installation.

Depending on environmental conditions, TimberTech Cladding colors may appear to change over time as part of the natural weathering process and consistent with applicable Fade & Stain Warranties.



CORTEX HIDDEN FASTENERS

The Cortex® hidden fastening system keeps the focus on the warm, authentic wood aesthetics, and not on the installation method.



Beautiful, efficient,
& long lasting



TRIM, MOULDING, AND SPECIALTY PROFILES

Trim beautifies a home, but its first job is protecting against water damage. AZEK® offers more trim sizes and solution-based moulding profiles than any other brand on the market. Using the insight of contractors, architects, and homeowners, we solve exterior problems. Installation is simplified and labor requirements are reduced. The high performance of AZEK products never compromises the beauty or integrity of the design.



Moisture Resistant



Rot Resistant



Insect Resistant



Weather Resistant



Durable, Less Long-Term Maintenance



Lightweight



Fire Resistant

OUR TRIM OUTPERFORMS WOOD

AZEK® Trim is made from 100% engineered polymer to provide a durable, long-lasting building material that is far more resistant to the elements than wood. No sealants are needed on surfaces or cut ends; every inch of our trim is equally protected against moisture. With superior uniformity, durability, workability, beauty, and much more, AZEK PVC Trim is the better choice.



	AZEK PVC TRIM	WOOD TRIM
UNIFORMITY		
Square edges	★	★
No knots, no waste – every inch usable	★	
DURABILITY		
Will not rot, split, splinter, delaminate, warp, or swell excessively from moisture	★	
Impervious to moisture and insect-resistant	★	† **
Suitable for ground and masonry contact	★	† **
Lifetime limited warranty	★	
Handles easily without breakage	★	★
WORKABILITY		
Use standard woodworking tools	★	★
Safely milled, shaped, and molded without special safety equipment	★	★
Can be heat-formed	★	
Fasten close to edge without predrilling	★	
BEAUTY		
Readily accepts paint*	★	★
Can be crafted for unique applications	★	†
EXTRAS		
Available in trim boards, sheets, cornerboards, beadboard, and mouldings	★	
Special labor-saving solution profiles available	★	

★ ALL PRODUCTS MEET CRITERIA
 † SOME PRODUCTS MEET CRITERIA

GET FREE TRIM
 SAMPLES WITH
 PAINTPRO®
 TECHNOLOGY



PROTECTIVE FILM KEEPS CLASSIC WHITE TRIM CLEAN

A superior performing trim has to look good too. That's why Classic AZEK Trim with protective film is available for smooth and woodgrain finishes. To ensure it looks as beautiful on your client's home as it does when it leaves our facilities, a protective film preserves AZEK Trim's crisp white semi-matte finish.

NOMINAL THICKNESS	NOMINAL WIDTH						
	4	5	6	8	10	12	16
5/4	SW	SW	SW	SW	SW	SW	SW
4/4	SW	SW	SW	SW	SW	SW	SW
5/8	SW	SW	SW	SW	SW	SW	SW

The film protects AZEK Trim through every production phase:

- Shipping
- Repackaging
- Installation
- Storage
- Handling

AZEK Trim with protective film should be kept dry prior to installation. Do not expose film to direct sunlight for extended periods. Protective film can be removed prior to, during, or immediately after installation.

*PaintPro must be painted within 180 days of installation. Visit [AZEKExteriors.com/products/trim/trim-boards/paintpro-trim](https://www.azekexteriors.com/products/trim/trim-boards/paintpro-trim).
 ** Partially, with chemical treatments.



AZEK TRIM

Trim comes in the sizes and dimensions pros want, with choices of smooth and woodgrain finish in Classic White or reversible smooth/woodgrain with PaintPro® Technology. New for 2025 is "two-by" thick, 8/4 reversible trimboards enhanced with PaintPro.

NEW 8/4 X THICKNESS			
NOMINAL	ACTUAL	16'	18'
8/4 x 2	1 1/2" x 1 1/2"	P	
8/4 x 4	1 1/2" x 3 1/2"	P	S
8/4 x 6	1 1/2" x 5 1/2"	P	S
8/4 x 8	1 1/2" x 7 1/2"	P	S
8/4 x 10	1 1/2" x 9 1/2"	P	S
8/4 x 12	1 1/2" x 11 1/2"	P	S

6/4 X THICKNESS		
NOMINAL	ACTUAL	20'
6/4 x 4	1 1/2" x 3 1/2"	W
6/4 x 6	1 1/2" x 5 1/2"	W
6/4 x 8	1 1/2" x 7 1/2"	W
6/4 x 10	1 1/2" x 9 1/2"	W
6/4 x 12	1 1/2" x 11 1/2"	W

5/4 X THICKNESS					
NOMINAL	ACTUAL	12'	16'	18'	20'
5/4 x 4	1" x 3 1/2"	SW	P	SW	SW
5/4 x 5	1" x 4 1/2"	SW		SW	SW
5/4 x 6	1" x 5 1/2"	SW	P	SW	SW
5/4 x 8	1" x 7 1/2"	SW	P	SW	SW
5/4 x 10	1" x 9 1/2"	SW	P	SW	SW
5/4 x 12	1" x 11 1/2"	SW	P	SW	SW
5/4 x 16	1" x 15 1/2"	SW	P	SW	SW

4/4 X THICKNESS					
NOMINAL	ACTUAL	12'	16'	18'	
1 x 2	3/4" x 1 1/2"		P	SW	
1 x 3	3/4" x 2 1/2"		P		
1 x 4	3/4" x 3 1/2"	SW	P	SW	
1 x 5	3/4" x 4 1/2"	SW		SW	
1 x 6	3/4" x 5 1/2"	SW	P	SW	
1 x 8	3/4" x 7 1/2"	SW	P	SW	
1 x 10	3/4" x 9 1/2"	SW	P	SW	
1 x 12	3/4" x 11 1/2"	SW	P	SW	
1 x 16	3/4" x 15 1/2"	SW	P	SW	

5/8 X THICKNESS		
ACTUAL	12'	18'
5/8" x 3 1/2"	SW	SW
5/8" x 5 1/2"	SW	SW
5/8" x 7 1/2"	SW	SW
5/8" x 9 1/2"	SW	SW
5/8" x 11 1/2"	SW	SW
5/8" x 15 1/2"	SW	SW

*AZEK Trim, including 8/4 boards, is not suitable for structural use.

SHEET

Applications over 16" wide are easy with AZEK Sheet. Use Sheet for bay windows, dormers, and raised panels.

SHEET					
ACTUAL	8'	10'	12'	18'	20'
3/8" x 4'	SW	SW	S	S	
1/2" x 4'	SWP	SWP	SP	S	
5/8" x 4'	S	S	S	S	
3/4" x 4'	SWP	SWP	S	S	
1" x 4'	S	S	S	S	S



ATM Sheet Sheet PaintPro Sheet

AZEK-TO-MILL

ATM's thick profile makes it an ideal material for fabrication. Its consistent density offers a superior product for milling operations.

AZEK-TO-MILL					
ACTUAL	8'	10'	12'	18'	20'
1 1/2" x 9 1/2"				S	
1 1/2" x 3 1/2"				S	
1 1/2" x 5 1/2"				S	
1 1/2" x 7 1/2"				S	
1 1/2" x 9 1/2"				S	
1 1/2" x 11 1/2"				S	
1 1/2" x 48" Sheet	S				
1 1/2" x 48" Sheet	S	S	S		S

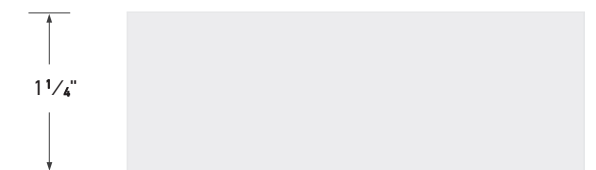

Smooth Finish (S) Woodgrain Finish (W) PaintPro Technology (P)



FLANGE SLOTTED & RABBETED TRIM

Flange Slotted Window Trim and Rabbeted Trim are engineered to create beautiful, consistent, and long-lasting window surrounds by removing the installation challenges. Rabbeted Trim is ideal for replacing existing trim. The cut flange easily covers existing siding. Ideal for new construction, the Flange Slotted and Rabbeted Trim has a 3/4" pocket, and, if using a vinyl window, the nailing fin will be hidden. The relief on the back of the board allows it to sit over the nailing flange without shimming.

FLANGE SLOTTED TRIM		
NOMINAL	ACTUAL	18'
5/4 x 4" Slotted	1" x 3 1/2"	SW
5/4 x 6" Slotted	1" x 5 1/2"	SW

RABBETED TRIM (1" x 1" channel)		
NOMINAL	ACTUAL	18'
5/4 x 4	1" x 3 1/2"	SWP
5/4 x 6	1" x 5 1/2"	SW
5/4 x 8	1" x 7 1/2"	SW

FLANGE SLOTTED AND RABBETED TRIM		
NOMINAL	ACTUAL	18'
5/4 x 4" Slotted & Rabbeted	1" x 3 1/2" with 1/2" Rabbeted Channel	SW
5/4 x 6" Slotted & Rabbeted	1" x 5 1/2" with 1/2" Rabbeted Channel	SW

Flange Slotted Trim
The flange slot helps trim sit flush over a window's nailing flange.



Rabbeted Trim with Siding Pocket
This 1" trim is perfect for end wall terminations.



Flange Slotted Rabbeted Trim with Window and Siding Pocket
The ultimate trim to build a neat, professional window surround.

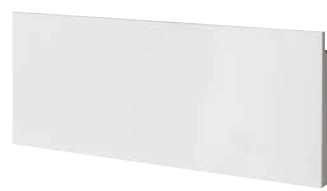

CORNERBOARDS

AZEK® Cornerboards offer faster installations and a seamless finish to complement any home exterior. Unlike two-piece cornerboards, which attract dirt in the seam, our one-piece cornerboards feature smooth outside edges to keep dirt away during installation.

CORNERBOARD			
NOMINAL	ACTUAL	10'	20'
5/4 x 4" x 4"	1" x 3 1/2" x 3 1/2"	SW	SWP
5/4 x 6" x 6"	1" x 5 1/2" x 5 1/2"	SW	SWP
5/4 x 8" x 8"*	1" x 7 1/4" x 7 1/4"		S

RABBETED CORNERBOARD			
NOMINAL	ACTUAL	10'	20'
5/4 x 4" x 4"	1" x 3 1/2" x 3 1/2"	SW	SW
5/4 x 6" x 6"	1" x 5 1/2" x 5 1/2"	SW	SW
5/4 x 8" x 8"*	1" x 7 1/4" x 7 1/4"		S

INSIDE CORNERBOARD			
NOMINAL	ACTUAL	10'	20'
2" x 2"	1 1/2" x 1 1/2"		P

Cornerboard
Used with fiber cement or wood siding. Caulk would be used when siding butts up against square trim face.



Rabbeted Cornerboard
Most often used with vinyl siding, where siding tucks behind trim. No caulk is needed.



*5/4 x 8" x 8" only available in Traditional

Seamless cornerboards for quick, clean installation

The Problem

Multiple pieces require more time and labor. Caulk is required to combine two trim boards. Other materials are not approved for ground and masonry contact.



The Solution

Cornerboard means no seams, no caulk, and no paint required. Lengths up to 20' make installation faster.





One-Piece Skirt Board



Integrated Drip Edge



Universal Skirt Board

Save on installation time & cost without compromising beauty

The Problem

If using fiber cement, multiple pieces are needed and it is not approved for ground masonry contact.



The Solution

One-Piece Board is moisture resistant, approved for ground contact.



ONE-PIECE SKIRT BOARD

The perfect transition between siding and grade, the AZEK® One-Piece Skirt Board is designed to eliminate the need for a separate starter strip, skirt board, or flashing. In addition to its consolidated three-in-one function, the slanted top of the board helps drain water away from the structure and allows for easy application of paint.

ONE-PIECE SKIRT BOARD			
NOMINAL	ACTUAL	16'	18'
4/4 x 8	3/4" x 7 1/2"		SW
4/4 x 10	3/4" x 9 1/2"		SW
5/4 x 6	1" x 5 1/2"		SW
5/4 x 8	1" x 7 1/2"		SW
5/4 x 10	1" x 9 1/2"	P	SW



One-Piece Skirt Board
No starter strip needed.
One-piece design makes this profile ideal for painting.



INTEGRATED DRIP EDGE

Designed to assist with water management efforts around doors and windows. Comes in two pieces with a reversible trim board, one side in smooth finish and the other in woodgrain finish. Routed to accept a drip edge for channeling water away from window and door surrounds. This profile design is also ideal for band board installations.

INTEGRATED DRIP EDGE		
NOMINAL	ACTUAL	18'
5/4 x 4	1" x 3 1/2"	W
5/4 x 6	1" x 5 1/2"	W
1 1/2" nailing flange length		
1/8" drip edge overhang		

Integrated Drip Edge
Window and door surrounds assemble faster with the integrated nailing flange.



UNIVERSAL SKIRT BOARD

A two-piece skirt board in reversible classic smooth or woodgrain finish designed to assist with water management and material transitions. Routed with a universal siding interface for quick and easy installation. Unlike other skirt boards, the AZEK Universal Skirt Board works well with fiber cement, vinyl, or wood siding.* No starter strips needed.

UNIVERSAL SKIRT BOARD		
NOMINAL	ACTUAL	18'
5/4 x 6	1" x 5 1/2"	W
5/4 x 8	1" x 7 1/2"	W
5/4 x 10	1" x 9 1/2"	W
5/4 x 12	1" x 11 1/2"	W
1 1/2" nailing flange length		
1/2" drip edge overhang		

*Universal Skirt Board works with many products; ensure compatibility before purchase.

Universal Skirt Board
No starter strip needed, saves time on installation.





Reversible Beadboard



Shiplap

Options for ceilings and walls

Beadboards and Beaded Sheets offer broad and beautiful coverage for ceilings under raised decks or above the porch. Tongue-and-groove profiles can be oriented on walls horizontally or vertically. Just like all AZEK® Trim and Moulding, every product for exterior ceilings and walls is made from moisture-resistant, low-maintenance PVC and designed to elegantly complement and elevate the entire exterior.

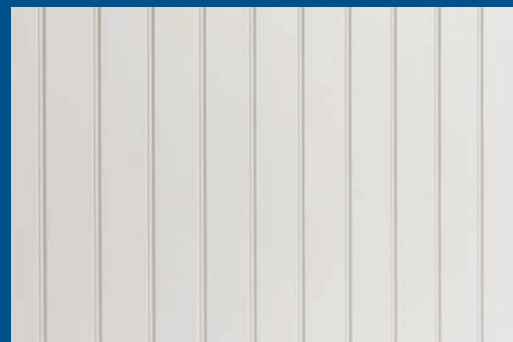

Beaded Sheet

NEW BEADBOARD E & CB EDGE & CENTER BEAD

AZEK® Beadboard (E & CB) is certified UL580 class 90 wind gust uplift-resistant, making it ideal for use in coastal areas. It is reversible and perfect for wainscoting, with an edge and center bead on one side and a v-groove on the other.

BEADBOARD	
ACTUAL	18'
½" x 3 ½"	S
¾" x 3 ½"	S
¾" x 5 ½"	S

BEADED SHEET	
ACTUAL	8'
½" x 4'	S



Beadboard (E & CB)
Add character to any wall or ceiling with the classic and cozy look of beadboard.



REVERSIBLE BEADBOARD

AZEK® Beadboard is reversible with an edge and center bead on one side and a V-groove on the other, perfect for wainscoting and porch ceilings.

BEADBOARD	
ACTUAL	18'
⅝" x 3 ½"	S
½" x 5 ½"*	S

*Features a nailing flange for easier installation.

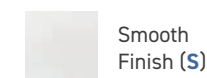

Reversible Beadboard V-Groove provides wider planks and a more formal aesthetic compared to beadboard on the reverse side.



SHIPLAP & NICKEL GAP

Bring the contemporary look of wider planks with either shiplap or nickel gap. Both deliver similar finished looks, but the tongue-and-groove nickel gap and reversible WP4 allow for hidden fasteners. Each profile type is suitable for horizontal or vertical orientation.

TONGUE-AND-GROOVE SHIPLAP	
ACTUAL	18'
¾" x 5 ½"	S
¾" x 7 ¼"	S

TONGUE-AND-GROOVE NICKEL GAP/WP4 (REVERSIBLE)	
ACTUAL	18'
¾" x 5 ½"	S



Shiplap
Combine with overlapping "rabbeted" joints.



Nickel Gap
Tongue-and-groove joints and reverse side offers V-groove aesthetic.





NEW ONE-PIECE COLUMN WRAP

This easy-to-install column wrap is made from a single piece of PVC and quickly dresses up a wood post. Glue the snap-fit seams, attach to the post, and trim to finish the architectural look.

ONE-PIECE COLUMN WRAP				
NOMINAL	INSIDE DIMENSION	OUTSIDE DIMENSION	8' 6"	10'
4 x 4	3 3/4" x 3 3/4"	4 3/4" x 4 3/4"	S	S
6 x 6	5 3/4" x 5 3/4"	6 3/4" x 6 3/4"	S	S
8 x 8	8 1/2" x 8 1/2"	9 1/2" x 9 1/2"	S	S



Column Wrap
Installs quickly with four precut interlocking boards

TAPERED COLUMN

The four-piece AZEK® Tapered Column combines a craftsman aesthetic with a column wrap's ease of installation. Four precut panels each feature a friction-fit miter lock joint to ensure a secure fit and the correct angle for each panel. Includes squaring corners and 3 1/2" decorative skirt pieces for the cap and base of each column to fasten and accessorize.

TAPERED COLUMN WITH BASE SKIRT		
ACTUAL	5'	6'
12" base / 8" cap	S	S
16" base / 12" cap	S	S

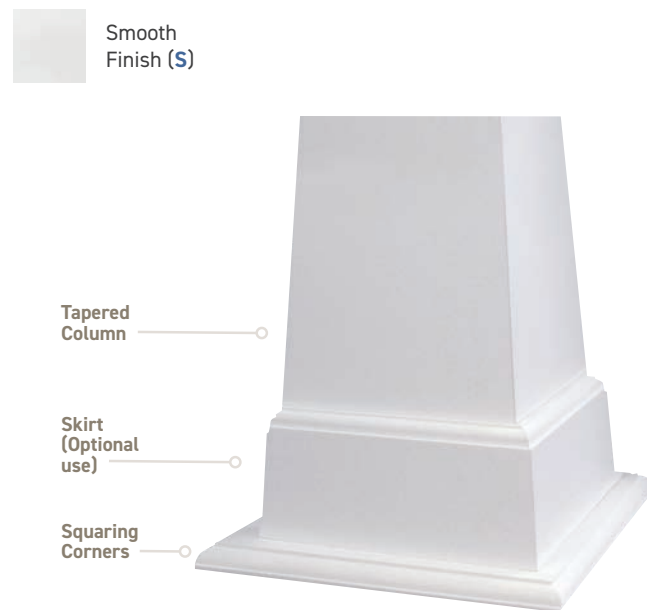

NEW ONE-PIECE COLUMN WRAP ACCESSORIES

Embellish your One-Piece Column Wraps with moulding kits and accent wraps. Use available accessory kits to enhance the column and give you the decorative look you desire.

THREE-PLUS-ONE COLUMN WRAP ACCESSORIES		
DESCRIPTION	4"	6"
TRIM KIT - BASE MLDG	S	S
TRIM KIT - BED MLDG	S	S
TRIM KIT - BED MLDG XL	S	S
TRIM KIT - CROWN MLDG	S	S
TRIM KIT - CROWN MLDG XL	S	S
ACCENT WRAP 10"	S	S



Column wrap accessories
Kits connect with precut dovetails to speed installation on decorative details.

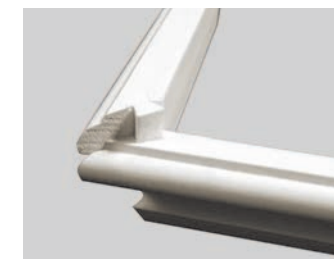



J-Casing

J-Channel

No caulk, no paint, fewer steps—faster installation

J-CASING

AZEK® J-Casing offers the most beautiful and seamless transition between siding and trim. Engineered to reduce labor and save costs by eliminating the need for field-applied paint and caulk.

J-CASING				
DESCRIPTION	ACTUAL	12'	16'	18'
1 x 4 J-Casing	1 1/8" x 3 1/2"		S	S
1 x 6 J-Casing	1 1/8" x 5 1/2"	S		
BRICK MOULD J-CASING				
DESCRIPTION	ACTUAL	18'		
Brick Mould J-Casing	1 1/2" x 2"	S		



J-CHANNEL QUICK CORNER™

Installed with hidden fasteners, completely eliminating the need for excessive face nailing and touch-up. Use with multiple types of sidings.

J-CHANNEL QUICK CORNER OUTSIDE CORNER		
DESCRIPTION	ACTUAL	20'
4 x 4 J-Quick Corner	1" x 3 1/2" x 3 1/2"	S
6 x 6 J-Quick Corner	1" x 5 1/2" x 5 1/2"	S
J-CHANNEL QUICK CORNER INSIDE CORNER		
DESCRIPTION	ACTUAL	20'
3 x 3 J-Quick Corner	3/8" x 2 1/2" x 2 1/2"	S

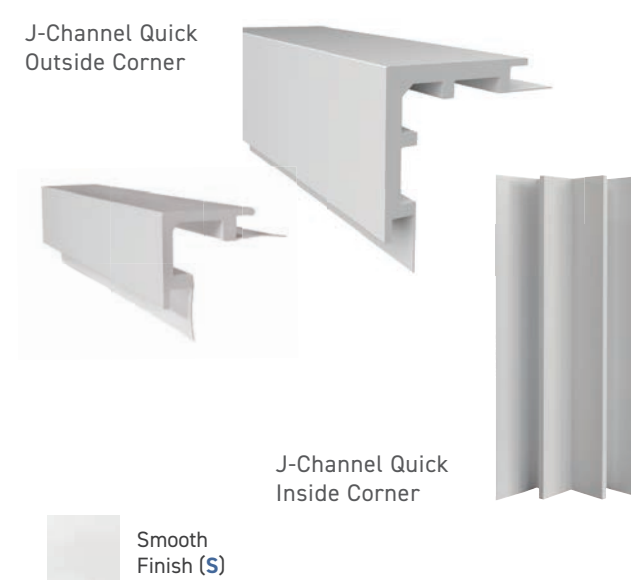

Seamless cornerboards make a quick, clean installation

The Problem

Requires separate purchase and use of trimboard and J-Channel.



The Solution

AZEK® J-Casing has an integrated J-Channel and doesn't require paint for protection, reducing installation time and cost.



The Problem

Caulked inside corners look messy and often are not watertight.



The Solution

J-Channel Inside Corner gives a clean, finished look, attaches with hidden fasteners, and works with most siding systems.





Vented Soffit with Notched Fascia and Frieze



Cortex

SOLID AND VENTED SOFFIT

Available in two profiles, solid and vented. Both provide beautiful finishing to match any home exterior with the durability of AZEK's climate-resistant material. The vented soffit has 8" of venting and 4" of solid pattern that provides 10" of free air space per lineal foot to meet or exceed most building codes for ventilation. Vents are cut at an angle to prevent insects from nesting; no additional screening necessary.

SOFFITS		
ACTUAL	VENTED 18'	SOLID 18'
½" x 12"	S	S
½" x 16"	S	S

Smooth Finish (S)



Soffit Solid and Vented

FRIEZE AND FASCIA

Use the frieze board and notched fascia for an efficient, easy-to-install soffit system. Both have a 1/2"-deep groove to smoothly join with soffits. The notched fascia requires no flashing or cover.

NOTCHED FASCIA		
NOMINAL	ACTUAL	18'
4/4 x 8"	¾" x 7 ½"	S

FRIEZE BOARD		
NOMINAL	ACTUAL	18'
5/4 x 6"	1" x 5 ½"	S

Fascia



Frieze



CORTEX FASTENING SYSTEM

Cortex® is the only concealed fastening system that quickly, easily, and securely fastens AZEK Trim to your building project. No need to caulk, sand, and paint nail holes. Cortex comes with plugs made of AZEK® material (Classic White, PaintPro, or matching any Cladding color). They are arranged on collated strips to make fastening faster. Available in paintable smooth or woodgrain finish.



Smooth Finish (S) Woodgrain Finish (W) PaintPro Technology (P)



Nickel Gap WP4
Harbor Ash

HIGH-END, POLISHED DETAIL



Nickel Gap WP4
Alaskan Cedar

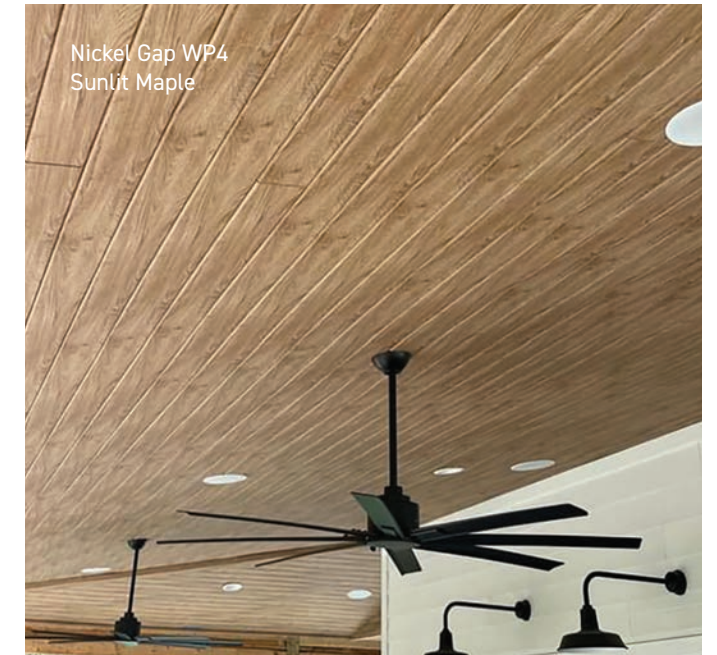

Nickel Gap WP4
Sunlit Maple

NICKEL GAP WP4

Nickel Gap delivers the modern, wide-plank look to your project. The WP4 profile enables hidden fasteners, whether arranged horizontally, vertically, or angled. Available in 18'.

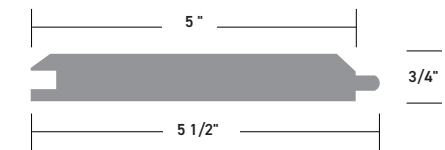

NEW AZEK ALPINE COLLECTION WEATHER-READY, FINISHED WOOD LOOK

Turn up the beauty and turn off maintenance worries with AZEK® Alpine in ceilings, soffits, porches, gazebos, accent walls, and more. Combining low-maintenance polymer materials with a final layer of realistic, warm woodgrain finishes, Alpine handles the outdoors effortlessly with a stained wood look that never needs refinishing.

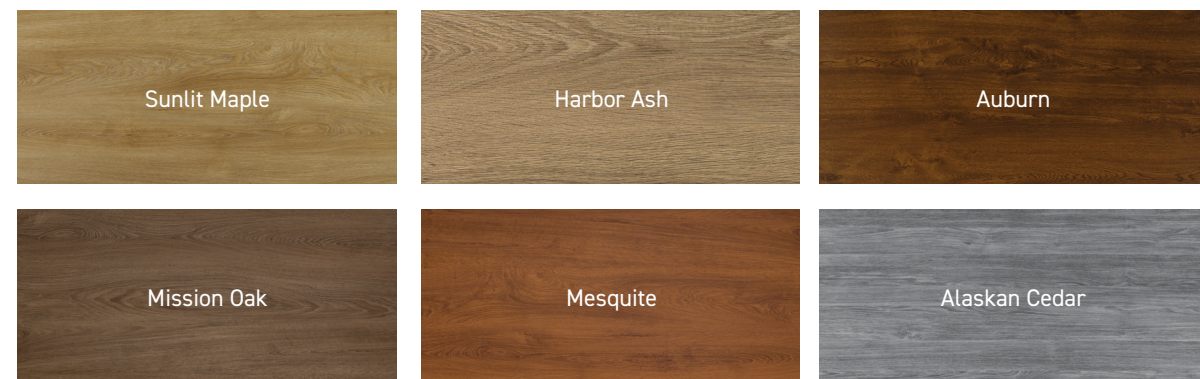

Beadboard
Mission Oak

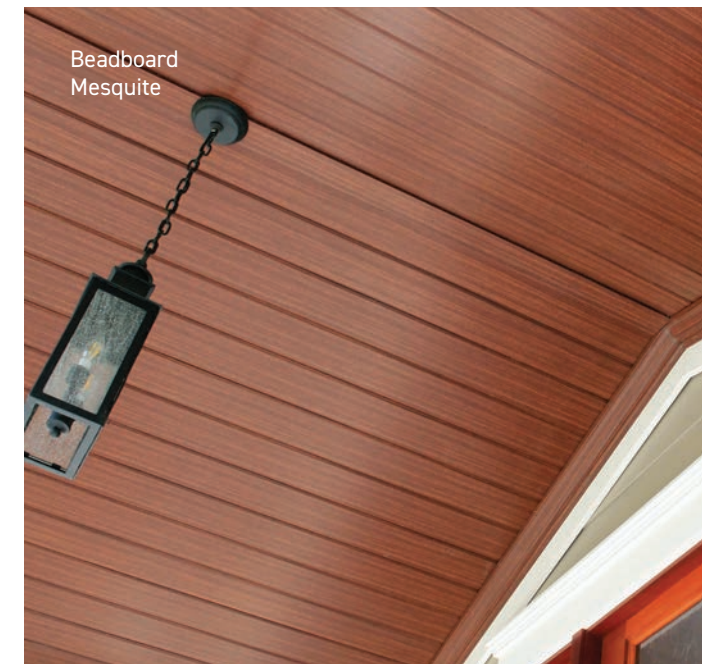

Beadboard
Mesquite

BEADBOARD

AZEK Alpine Beadboard provides a traditional, rustic farmhouse look with center bead and v-groove. Consistent interlocking design means tight joints and easy installation. Available in 18'.

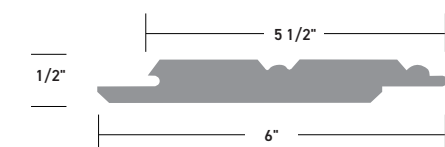

EXTERIOR MOULDING

TRADITIONAL BEAUTY, MODERN PERFORMANCE

BED MOULDING

Similar to crown moulding, a bed mould is used to cover the joint between the ceiling and wall.

RAMS CROWN

Consider installing Rams Crown at the top of a column or post, or use in place of a crown for a distinctive look.

CROWN MOULDING

Crown Moulding is used for a classic look, bridging the corner between the wall and ceiling.

BAND MOULDING

Band Moulding can be used alone or added to the base of a crown for a premium finish.



THE MOST BEAUTIFUL, DURABLE MOULDING LINE AVAILABLE

With crisp, architectural details reminiscent of premium wood mouldings, high-performance AZEK® Moulding will last beautifully without the maintenance hassles associated with wood. Backed by AZEK's promise of high quality and lasting performance, our moulding will retain a like-new appearance despite the tests of time and weather. AZEK cellular PVC offers greater stability and predictability when fastening and unlike traditional wood moulding resists moisture and insect damage and will not rot or split.

CROWN PROFILES

Crown moulding profiles are typically decorative mouldings designed for use along the intersection of a wall or ceiling. They may be combined with other mouldings to create a built-up profile.

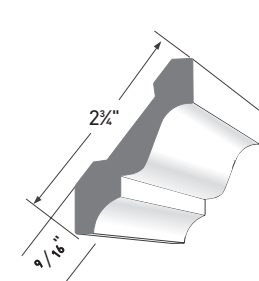

3" CROWN AZM-52
LENGTH: 16'

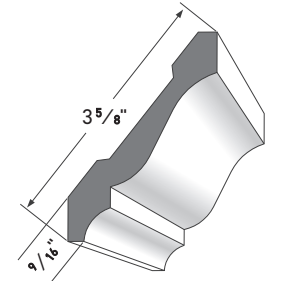

4" CROWN AZM-49
LENGTH: 16'

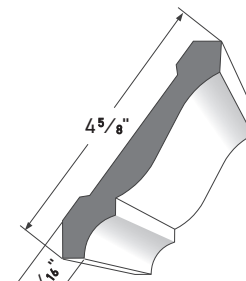

5" CROWN AZM-47
LENGTH: 16'

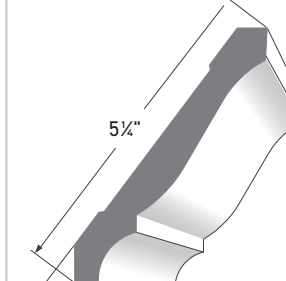

6" CROWN AZM-45
LENGTH: 16'

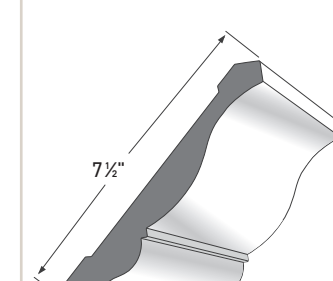

8" CROWN AZM-43
LENGTH: 16'

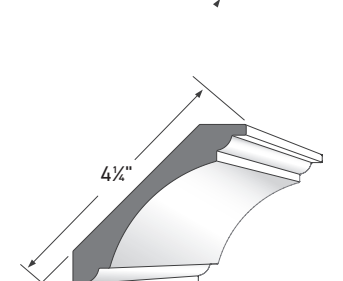

COVE MOULDING AZM-80
LENGTH: 16'

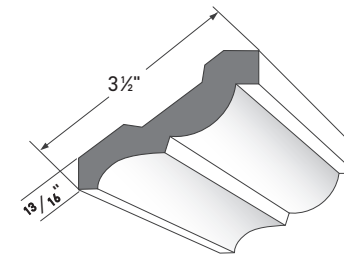

3 1/2" BED MOULDING AZM-28
LENGTH: 16'

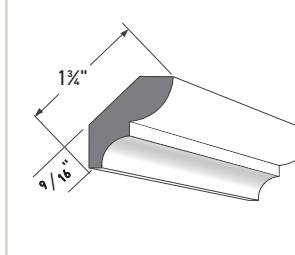

BED MOULDING AZM-75
LENGTH: 16'

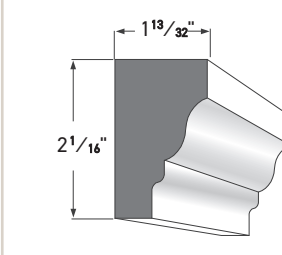

RAMS CROWN AZM-6934
LENGTH: 16'

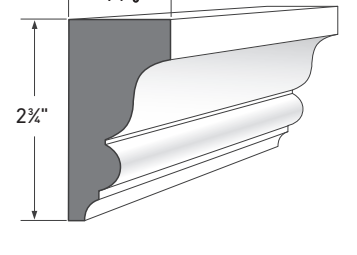

IMPERIAL RAKE CROWN
AZM-6937
LENGTH: 16'

NEW ➔

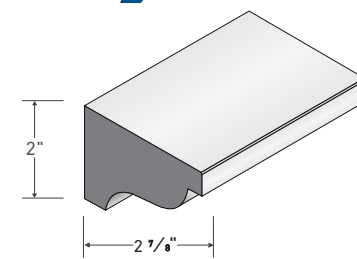

PEDIMENT CROWN
MOULDING AZM-1882
LENGTH: 12'

NEW ➔

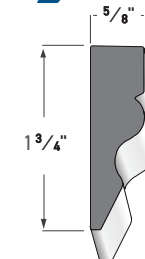

PANEL MOULD
AZM-165
LENGTH: 16'

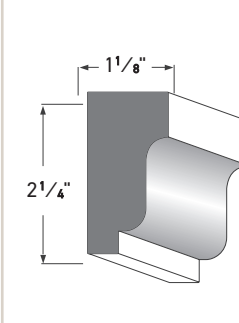

SOLID CROWN
AZM-7954
LENGTH: 16'

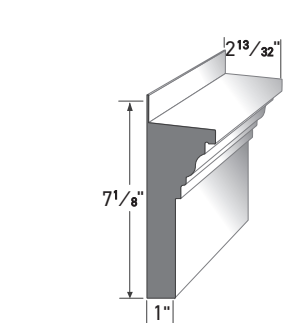

CROSSHEAD PEDIMENT
AZM-6216
LENGTH: 18'

DETAIL & SILL/DRIP PROFILES

AZEK® Drip profiles can be used as a water table or brick ledge for separation and watershed against two different materials. AZEK Sill profiles shed water and offer architectural detail.

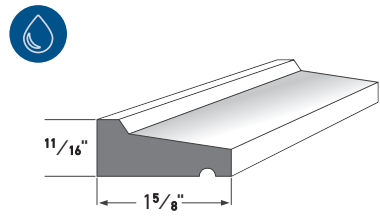
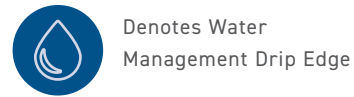

DRIP CAP AZM-197
LENGTH: 16'

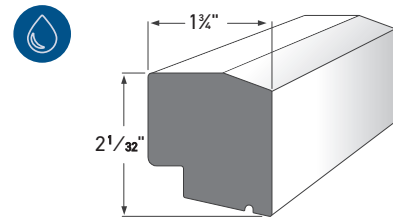

HISTORIC SILL AZM-6930
LENGTH: 16'

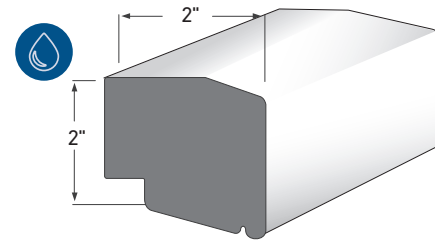

LARGE SILL NOSE AZM-7979
LENGTH: 16'

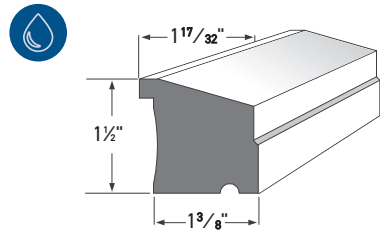

SUB SILL NOSE AZM-6933
LENGTH: 16'

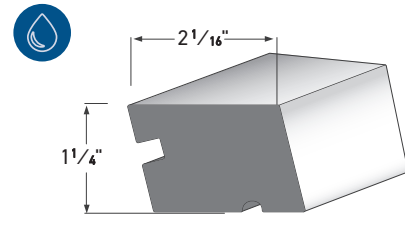

WINDOW SILL NOSE AZM-7974
LENGTH: 12'

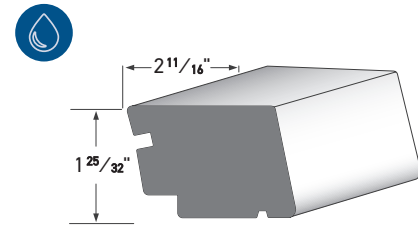

LARGE HISTORIC SILL AZM-7958
LENGTH: 16'

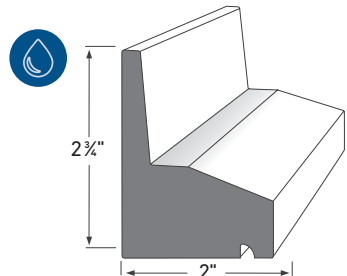

WATER TABLE AZM-6935
LENGTH: 18'

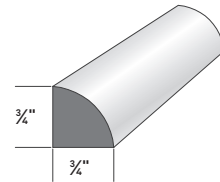

QUARTER ROUND AZM-105
LENGTH: 16'

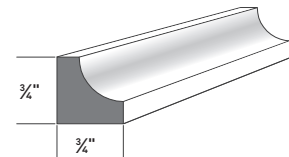

SCOTIA AZM-93
LENGTH: 16'

NEW ➔

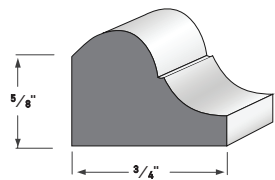

COVE AZM-7480
Length: 16'

NEW ➔

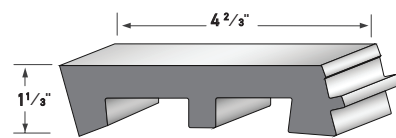

PCB SILL AZM-948
Length: 16'

NEW ➔

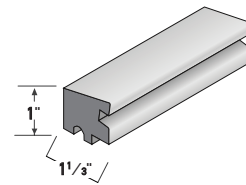

SILL NOSE AZM-937
Length: 16'

CASING PROFILES

Use AZEK® Casing Profiles as decorative moulding against a wall, door, or window to create surrounds. Elevate your framing with style and durability.

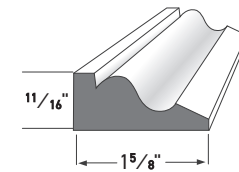

BAND MOULDING AZM-217
LENGTH: 16'

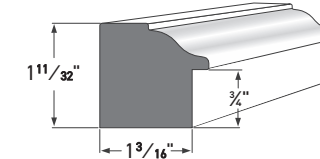

BACK BAND AZM-6931
LENGTH: 16'

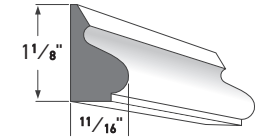

BASE CAP AZM-164
LENGTH: 16'

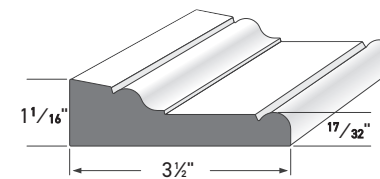

ADAMS CASING AZM-97
LENGTH: 16'

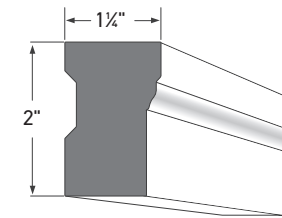

BRICK MOULD AZM-180
LENGTHS: 16', 17' and 18**

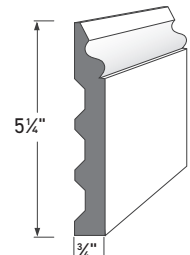

COLONIAL BASE CAP AZM-163
LENGTH: 16'

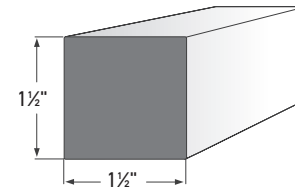

SQUARE PROFILE AZM-236
LENGTH: 12'

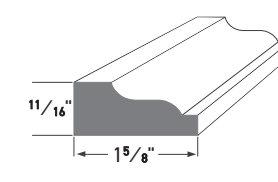

SHINGLE MOULD AZM-210
LENGTH: 16'

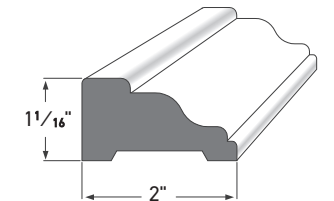

RAKE MOULDING AZM-287
LENGTH: 16'

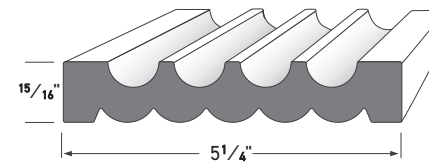

FLUTED/REEDED AZM-606
LENGTH: 16'

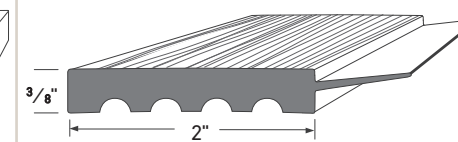

GARAGE DOOR THERMOSTOP AZM-6936 LENGTHS: 7', 9', and 16'

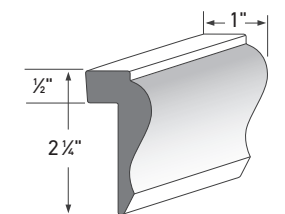

WAINSCOT CAP AZM-284
LENGTH: 16'

*18' Brick Mould (AZM-180) is available in full units only and cannot be ordered via the Pick & Pack program.

ADHESIVES & FASTENERS

The right adhesives and fasteners are essential to a quality job.

CORTEX FASTENING SYSTEM

Cortex® is the only concealed fastening system that quickly, easily, and securely fastens AZEK Trim to your building project. No need to caulk, sand, and paint nail holes. Cortex comes with plugs made of AZEK material on collated strips to make fastening faster. Available in paintable smooth or woodgrain finish. 220 ml: AAD220MLQM



Available in Classic AZEK Trim and PaintPro Trim

CELLULAR PVC CEMENT

Clear, contact-style adhesive bonds with PVC in a fast-working time. Ideal for securing joints. Creates a powerful and reliable material bond with no sanding or scraping required.

Squeeze Bottle
4 oz: AADB004OZ, 8 oz: AADB008OZ

Container with Applicator
4 oz: AAD004OZ, 8 oz: AAD008OZ,
16 oz: AAD016OZ, 32 oz: AAD032OZ,
128 oz: AAD128OZ, 640 oz: AAD640OZ

- 24-hour curing time
- Clamp 24–48 hours for best results
- Water-soluble for easy cleanup when surfaces are still wet
- Convenient applicator built into lid
- Use AZEK Adhesive to connect trim when a tight compression is required, such as connecting trim end-to-end (scarf joints) and at corners (miter joints)



FILL & FLEX

Use for expansion and contraction joints on PVC trim boards. Seals gaps around windows and doors. Slow curing, one-part urethane-based sealant with high level of flexibility and elongation to absorb expansion and contraction from heat or cold.

AAD300MLFF

- Premium-grade TiO₂ pigments
- Resists long-term yellowing
- Allows ample work time
- 300 ml



FAST CURE 220 ML-AAD220MLFCS

FAST CURE 50 ML-AAD50MLFCS

- White, two-part acrylic-based adhesive ideal for bonding AZEK to AZEK products; also bonds PVC to wood, metal, brick, vinyl, glass, and other PVC
- Work time 4–7 minutes at 70°F after mixing with Qwik-Mixer; fully cures in 24 hours
- Fills nail holes and gaps up to 1/8"
- Requires Qwik-Mixer for easy mixing and dispensing



SLOW CURE 220 ML -AAD220MLSCS

SLOW CURE 50 ML-AAD50MLSCS

- White, two-part acrylic-based adhesive ideal for bonding AZEK® to AZEK products; also bonds PVC to wood, metal, brick, vinyl, glass, and other PVC
- Work time 15–25 minutes at 70°F after mixing with Qwik-Mixer; fully cures in 24 hours
- Fill nail holes and gaps up to 1/2"
- Requires Qwik-Mixer for easy mixing and dispensing



MANUAL 50 ML DISPENSE GUN
Made of highly engineered plastic to be lightweight and powerful. Easy loading breech provides secure cartridge fit. AAD50MLMG



MANUAL 220 ML DISPENSE GUN
Its 26:1 mechanical advantage dispenses high- and low-viscosity adhesives with less user fatigue. Designed to maximize durability. AAD220MLHF



QWIK-MIXERS (24/PK)

Required dispenser for Fast Cure and Slow Cure AZEK adhesive products. The resin and catalyst blend together as they travel down the tube to the applicator tip. Ensures 1:1 ratio mix and provides easy adhesive application. 24 per pack.

50 ml: AAD50MLSQM

220 ml: AAD220MLQM



PVC TRIM NAIL ERASERS

Fills finish nail holes in PVC trim. White color perfectly matches AZEK trim. Resists yellowing.

.5 oz: AADNEBLIS



PLASTIC JOINING BISCUIT (50/PK)

PVC-compatible biscuits. Easy way to join, seal, and finish PVC Trim.

BISCUIT PACK OF 50: AADPJB

Industry-Leading Warranties

With decades in the business and dedicated investments to research and development, AZEK makes it our mission to provide the best materials on the market. We stand behind the integrity of our siding, cladding, trim, and moulding with a Lifetime Limited Warranty that covers corrosion, rotting, splintering, delamination, or swelling excessively from moisture. All AZEK products are also easy to maintain and resistant to mold, mildew, and moisture damage. For more information, visit AZEKExteriors.com/warranty.

Contractor and Builder Information

AZEK Trim, Siding, and Moulding and TimberTech Cladding should be installed using the same good building principles used to install wood trim and mouldings and in accordance with the local building codes and established installation guidelines. AZEK accepts no liability or responsibility for the improper installation of AZEK products.

AZEK Siding, Trim, and Moulding may not be suitable for every application, and it is the sole responsibility of the installer to be sure that AZEK Siding, Trim, and Moulding, and TimberTech Cladding are fit for the intended use. Since all installations are unique, it is also the installer's responsibility to determine specific requirements in regard to each application. AZEK recommends that all applications be reviewed by a licensed architect, engineer, or local building official before installation.

Technical information and AZEK Trim, Siding, and Moulding installation guides are available at AZEKExteriors.com/resources or from a local AZEK dealer. For further assistance, please call AZEK Customer Service at 1.800.910.3545 or visit our website at AZEKExteriors.com.

ACCESSORIES

NEW FOR 2025

AZEK Exteriors expands and improves its full line of building materials with these additions.



ALPINE COLLECTION

The look of finished wood. *See page 52*



8/4 PAINTPRO TRIM

"Two-by" thickness, ready for paint. *See page 38*



BEADBOARD

Reversible boards for more options. *See page 44*



COLUMN WRAP

Classic elegance made simple. *See page 46*